

Ring Main Unit

RM6 24 kV

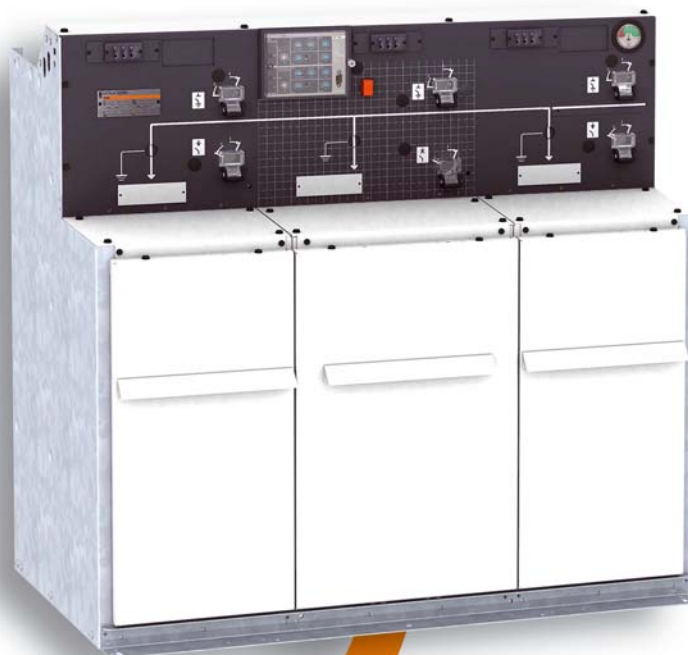

Catalogue

2007

The Guiding System, the new way to create your electrical installations

A comprehensive offer of products with consistent design

The Guiding System is first and foremost a Merlin Gerin product offer covering all electrical distribution needs. However, what makes all the difference is that these products have been designed to operate together: mechanical and electrical compatibility, interoperability, modularity, communication.

Thus the electrical installation is both optimised and more efficient: better continuity of supply, enhanced safety for people and equipment, guaranteed upgradeability, effective monitoring and control.

Tools to simplify design and implementation

With the Guiding System, you have a comprehensive range of tools - the Guiding Tools - that will help you increase your product knowledge and product utilisation. Of course this is in compliance with current standards and procedures.

These tools include technical booklets and guides, design aid software, training courses, etc. and are regularly updated.

The Guiding System, combined with the know-how and creativity, allows optimised, reliable, open-ended and standard compliant installations

For a genuine partnership with you

Because each electrical installation is unique, there is no standard solution. With the Guiding System, the variety of combinations allows for genuine customisation solutions. You can create and implement electrical installations to meet your creative requirements and design knowledge.

You and Merlin Gerin's Guiding System form a genuine partnership.

For more details on the Guiding System, consult www.merlin-gerin.com

A consistent design of offers from Medium Voltage to Low Voltage

All Merlin Gerin offers are designed according to electrical, mechanical and communication consistency rules. The products express this consistency by their overall design and shared ergonomics.



Discrimination guarantees co-ordination between the operating characteristics of serial-connected circuit-breakers. Should a fault occurs downstream, only the circuit-breaker placed immediately upstream from the fault will trip.



Direct connection of the Canalis KT busbar trunking on the Masterpact 3200 A circuit breaker.

Transparent Ready

Thanks to the use of standard Web technologies, you can offer your customers intelligent Merlin Gerin switchboards allowing easy access to information: follow-up of currents, voltages, powers, consumption history, etc.

**Guiding Tools
for more efficient design
and implementation
of your installations.**

Electrical consistency:

Each product complies with or enhances system performance at co-ordination level: breaking capacity, I_{sc} , temperature rise, etc. for more safety, continuity of supply (discrimination) or economic optimisation (cascading).

The leading edge technologies employed in Merlin Gerin's Guiding System ensure high performance levels in discrimination and cascading of protection devices, electrodynamic withstand of switches and current distributors, heat loss of devices, distribution blocks and enclosures.

Likewise, inter-product ElectroMagnetic Compatibility (EMC) is guaranteed.

Mechanical consistency:

Each product adopts dimensional standards simplifying and optimising its use within the system.

It shares the same accessories and auxiliaries and complies with global ergonomic choices (utilisation mode, operating mode, setting and configuration devices, tools, etc.) making its installation and operation within the system a simpler process.

Communication consistency:

Each product complies with global choices in terms of communication protocols (Modbus, Ethernet, etc.) for simplified integration in the management, supervision and monitoring systems.

SM6

Medium voltage switchboard system from 1 to 36 kV



Sepam

Protection relays



Masterpact

Protection switchgear from 100 to 6300 A



Trihal

MV/LV dry cast resin transformer from 160 to 5000 kVA

Evolis

MV vacuum switchgear and components from 1 to 24 kV.

The Technical guide

These technical guides help you comply with installation standards and rules i.e.: The electrical installation guide, the protection guide, the switchboard implementation guide, the technical booklets and the co-ordination tables all form genuine reference tools for the design of high-performance electrical installations. For example, the LV protection co-ordination guide - discrimination and cascading - optimises choice of protection and connection devices while also increasing markedly continuity of supply in the installations.



CAD software and tools

The CAD software and tools enhance productivity and safety. They help you create your installations by simplifying product choice through easy browsing in the Guiding System offers. Last but not least, they optimise use of our products while also complying with standards and proper procedures.



Compact

Protection switchgear system from 100 to 630 A



Multi 9

Modular protection switchgear system up to 125 A



Prisma Plus

Functional system for electrical distribution switchboards up to 3200 A



Pragma

Enclosures for distribution switchboards up to 160 A

Canalis

Prefabricated Busbar Trunking from 25 to 4000 A

PowerLogic

Power management

Training

Training allows you to acquire the Merlin Gerin expertise (installation design, work with power on, etc.) for increased efficiency and a guarantee of improved customer service.

The training catalogue includes beginner's courses in electrical distribution, knowledge of MV and LV switchgear, operation and maintenance of installations, design of LV installations to give but a few examples.



merlin-gerin.com

This international site allows you to access all the Merlin Gerin products in just 2 clicks via comprehensive range data-sheets, with direct links to:

- complete library: technical documents, catalogs, FAQs, brochures...
- selection guides from the e-catalog
- product discovery sites and their Flash animations.

You will also find illustrated overviews, news to which you can subscribe, the list of country contacts...



Guiding

TOOLS

merlin-gerin.com

This international site allows you to access all the Merlin Gerin products in just 2 clicks via comprehensive range data-sheets, with direct links to:

- complete library: technical documents, catalogs, FAQs, brochures...
- selection guides from the e-catalog.
- product discovery sites and their Flash animations.

You will also find illustrated overviews, news to which you can subscribe, the list of country contacts...



The technical guide

These technical guides help you comply with installation standards and rules i.e.: the electrical installation guide, the protection guide, the switchboard implementation guide, the technical booklets and the co-ordination tables all form genuine reference tools for the design of high performance electrical installations.

For example, the LV protection co-ordination guide - discrimination and cascading - optimises choice of protection and connection devices while also increasing markedly continuity of supply in the installations.



Presentation		
Applications	2	Presentation
Range advantages	4	
Experience of a world leader	6	
Protecting the environment	7	
Quality - Standards	8	
The RM6 range		
RM6 switchgear description	9	The RM6 range
Medium voltage metering – NEW FEATURE 2007	10	
Safety of people	11	
A wide choice of functions	13	
Unit characteristics		
Main characteristics	14	Unit characteristics
Detailed characteristics for each function	15	
Line protection by a 630 A circuit breaker	23	
Transformer protection by a 200 A circuit breaker	25	
Transformer protection by fuse-switches	26	
Network remote control		
The Easergy interface	27	Network remote control
Switch and circuit breaker motorization	29	
Accessories		
Indication and tripping	30	Accessories
Fault current indicator	31	
Voltage presence indicator	32	
Key locking	33	
MV connection		
Selecting bushings and connectors	34	MV connection
Connections proposed in the offer	35	
Other types of compatible connections	36	
Installation		
Dimensions and installation conditions	38	Installation
Civil works	42	
Order form		
Available functions	43	Order form
Basic unit and options	44	
Options and accessories	45	

The RM6 can be adapted to meet all Medium Voltage power distribution needs, up to 24 kV.

The RM6 is a compact unit combining all MV functional units to enable connection, supply and protection of one or two transformers on an open ring or radial network:

- by a fuse-switch combination, up to 2000 kVA
- by a circuit breaker with self-powered protection unit, up to 3000 kVA.

The switchgear and busbars are enclosed in a gas-tight chamber, filled with SF6 and sealed for life.

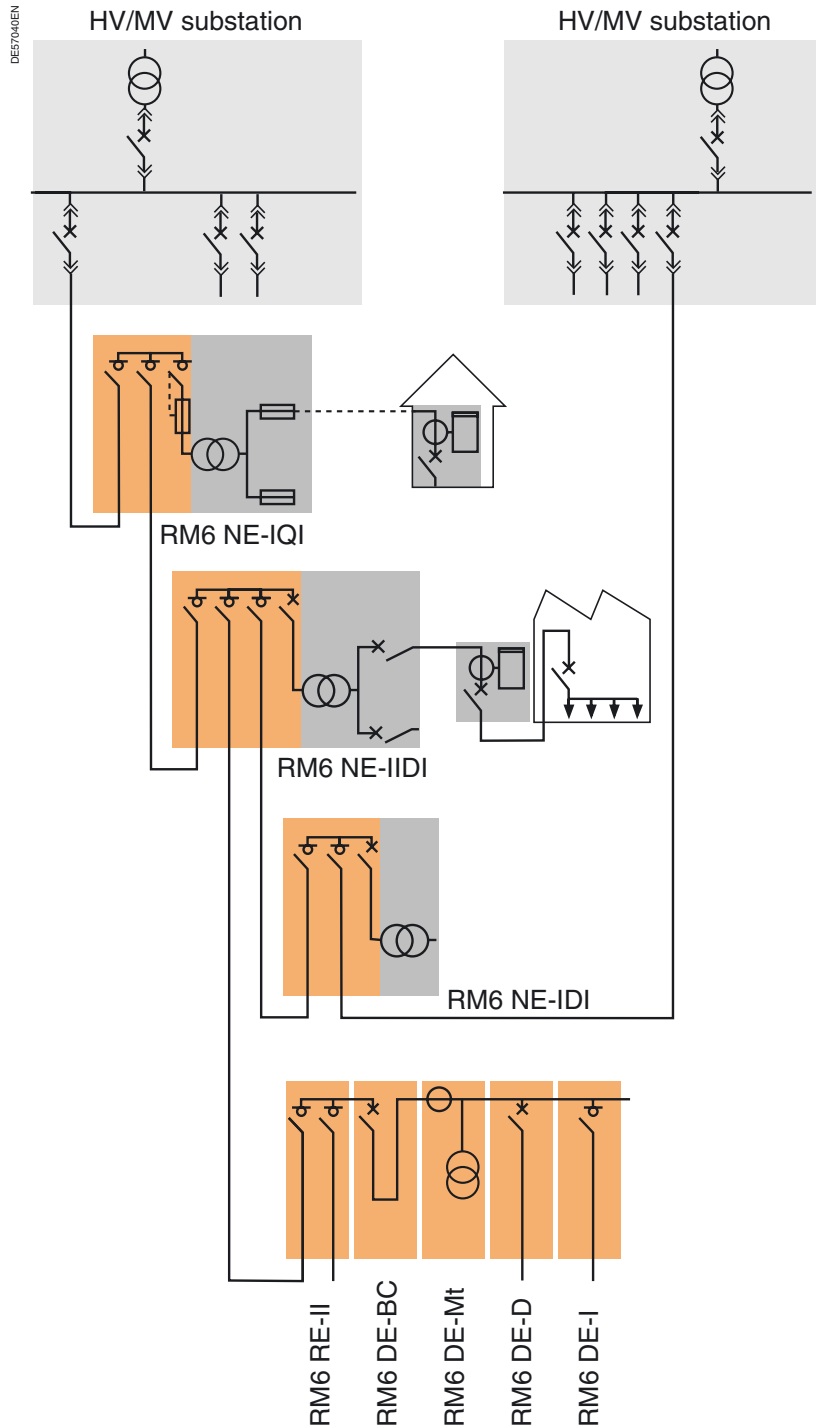

A complete range, enabling you to equip MV network points, and enhance electrical power dependability.

Operating a distribution network sometimes requires switching points in addition to the HV/MV substations, in order to limit the effect of a fault on the network.

The RM6 offers a choice of solutions to make 2, 3 or 4 directional connections

- with line protection by 630 A circuit breakers
- with network switching by switch disconnectors
- with integrated power supply telecontrol devices.

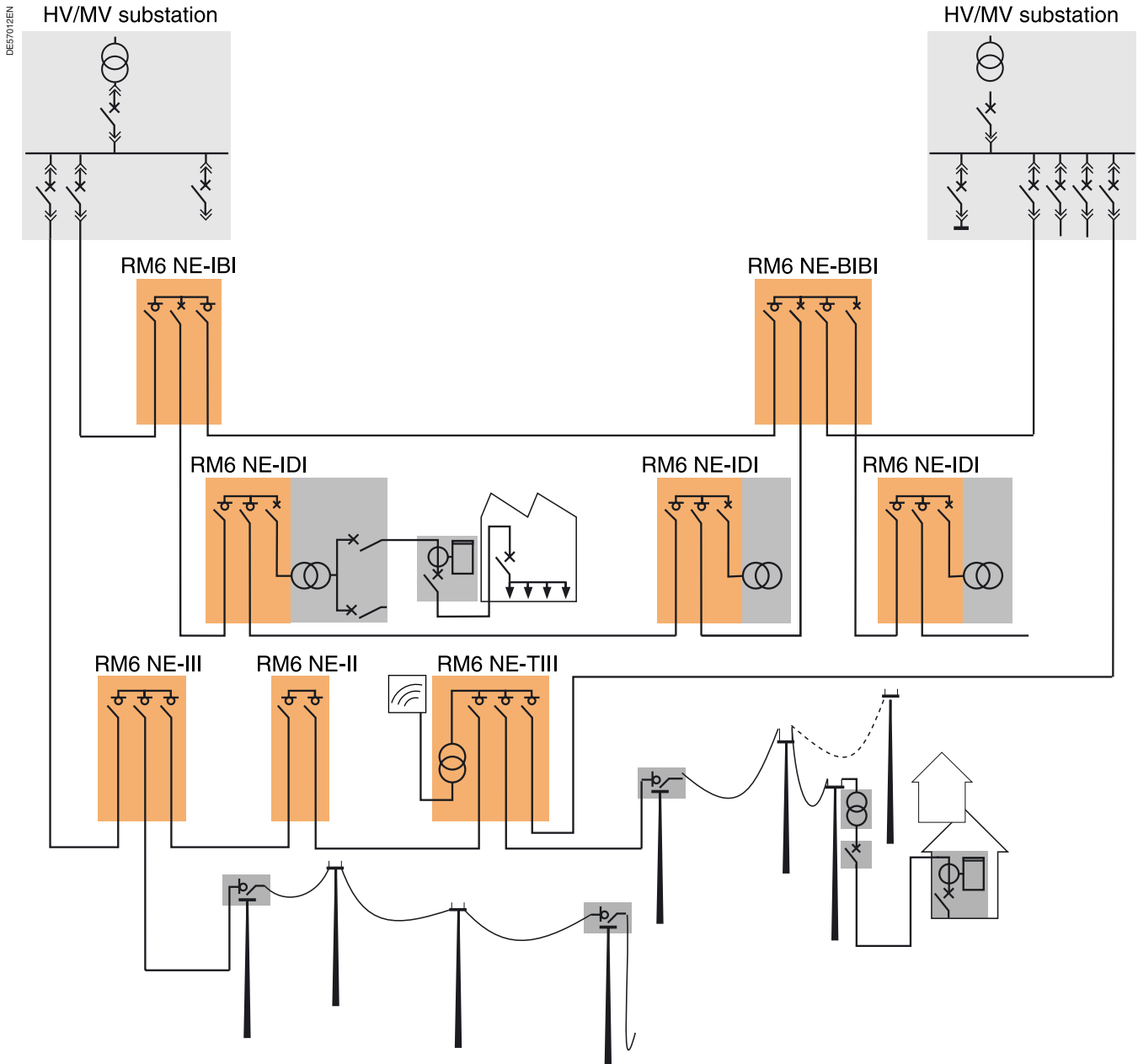

Choosing RM6 offers you the experience of a world leader in the field of Ring Main units.

The choice for your peace mind

The new RM6 generation benefits from the accumulated experience acquired from the 850,000 functional units that equip electrical networks in more than 50 countries in Africa, America, Asia, Europe and Australasia. With 20 local production units around the world, Merlin Gerin offer products can be made available to you in the shortest possible time.

Ring Main Unit, long experience

- 1983: marketing launch of the first RM6 compact with integrated insulation.
- 1987: creation of the circuit breaker version, with integrated protection unit needing no auxiliary power supply.
- 1990: creation of the RM6 1 functional unit.
- 1994: creation of the Network Point, integrating the RM6 and telecontrol.
- 1998: creation of the 630 A line protection integrated relay circuit breaker and launch of an RM6 range that is extensible on site.
- 2007 : creation of the MV metering offer and associated functions (metering module, busbar coupling module, cable connection module).

1983



1987



1998



Advantages of a proven design

RM6 switchgear

■ Ensures personal safety:

- internal arc withstand in conformity with IEC 62271-200
- visible earthing
- 3 position switchgear for natural interlocking
- dependable position indicating devices.

Is insensitive to the environment:

- stainless steel tank, degree of protection IP67
- disconnectable, sealed, metallized fuse chambers.

Is of approved quality:

- conforms to national and international standards
- design and production are certified to ISO 9000 (version 2000)
- benefits from the experience accumulated from 850,000 functional units installed world-wide.

Respects the environment:

- end-of-life gas recovery possible
- ISO 14001 approved production site.

Is simple and rapid to install:

- front cable connections at the same height
- easily fixed to the floor with 4 bolts.

Is economical:

- from 1 to 4 functional units, integrated within the same metal enclosure for which insulation and breaking take place in SF6 gas
- lifetime of 30 years.

Has maintenance free live parts:

- in conformity with IEC 60694, pressure system, sealed for life.

Compact and scalable, the RM6 range covers all of your requirements

PE60411



Compact

RM6 Medium Voltage switchgear cubicles are perfectly suited for very simple configuration of 1 to 4 functions.

- Choice of “**all in one**” units integrated in a single metal enclosure
- Cubicles insensitive to climatic conditions
- Optimized dimensions
- Quick installation through floor fixing with four bolts and front cable connection.

Extensible

Just as compact and insensitive to climatic conditions **the extensible RM6 is modular to suit your requirements.**

The addition of **functional unit modules** allows you to build the Medium Voltage switchboard suited to your requirements.

Your organization develops, you build a new building - RM6 adapts with you.

It can be extended on site without handling gases or requiring any special floor preparation **to develop your installation simply and in complete safety.**

Circuit breakers, for greater safety and lower costs

PE60412EN

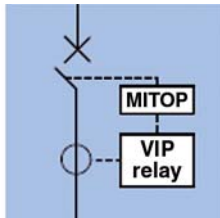

The RM6 range offers 200 A and 630 A circuit breakers to protect both transformers and lines. They are associated with independent protection relays that are self-powered via current sensors.

■ **Greater operating staff safety and improved continuity of service**

- increased protection device co-ordination with the source substation, circuit breaker and the LV fuses
- rated current is normally high, allowing use of a circuit breaker to provide disconnection
- the isolating system is insensitive to the environment.

■ **Simplified switching operations and remote control**

■ **Reduction of losses**

- thanks to the low value of RI^2 (the fuse-switches of a 1000 kVA transformer feeder can dissipate 100 W.

■ **Reduced maintenance costs.**

- no work in progress to replace fuses.

RM6, a world-wide product



Norway

MT55156



Sweden

MT55157

DE57036



Spain

MT55158



Russia

MT55159



Australia

MT55160

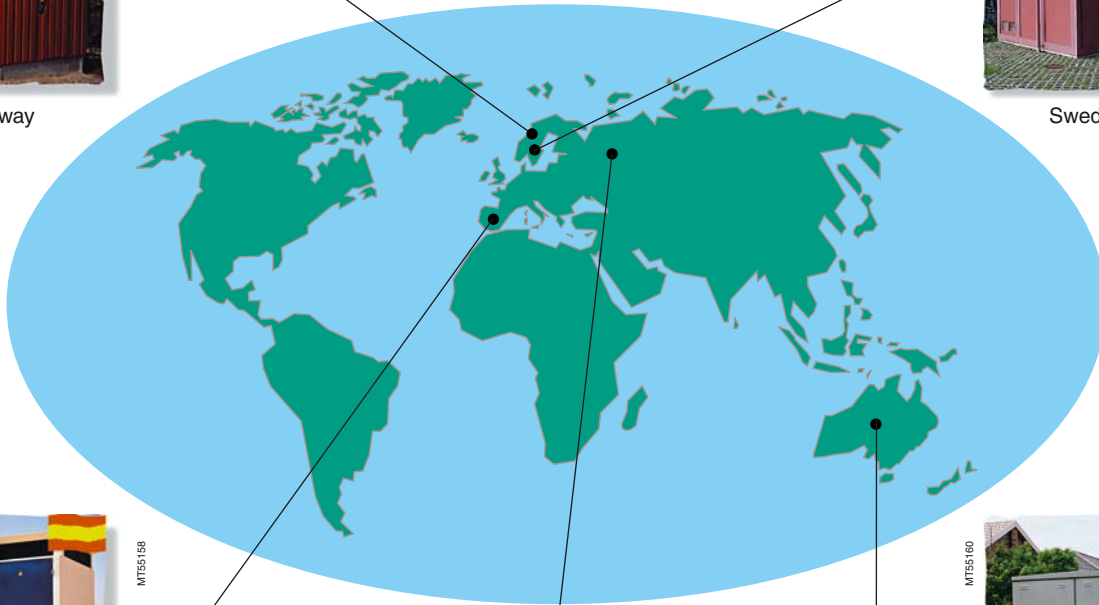

Main references

Asia/Middle East

- BSED, Bahrein
- DEWA, Dubaï
- WED, Abu Dhabi
- Tianjin Taifeng Industrial Park, China
- TNB, Malaysia
- China Steel Corporation, Taiwan
- TPC, Taiwan
- SCECO, Saudi Arabia
- PSB, China

Africa

- Electricité de Mayotte
- EDF Reunion
- Total, Libya
- SONEL, Cameroon
- South Africa

South America/Pacific

- CELESC, Santa Catarina, Brazil
- PETROBRAS, Rio de Janeiro, Brazil
- Guarulhos International Airport, Sao Paulo, Brazil
- CEMIG, Minas Gerais, Brazil

- EDF, French Guiana
- Tahiti Electricity
- Métro de Mexico, Mexico

Europe

- EDF, France
- Channel tunnel, France
- Iberdrola, Spain
- Compagnie Vaudoise d'électricité
- SEIC, Switzerland
- Electrabel, Belgium
- Union Fenosa, Spain
- ENHER, Spain
- Oslo Energie, Norway
- STOEN, Poland
- Bayernwerke, Germany
- London Electricity, United Kingdom
- Mosenergo, Russia

Australasia

- Eau et Electricité de Calédonie
- New-Caledonia
- Enercal, New-Caledonia
- United Energy, Australia

The Schneider Electric's recycling procedure for SF6 based products is subject to rigorous management, and allows each device to be traced through to its final destruction documentation.

The Schneider Electric's recycling procedure



Schneider Electric is committed to a long term environmental approach. As part of this, the RM6 range has been designed to be environmentally friendly, notably in terms of the product's recyclability. The materials used, both conductors and insulators, are identified and easily separable. At the end of its life, RM6 can be processed, recycled and its materials recovered in conformity with the draft European regulations on the end-of-life of electronic and electrical products, and in particular without any gas being released to the atmosphere nor any polluting fluids being discharged.

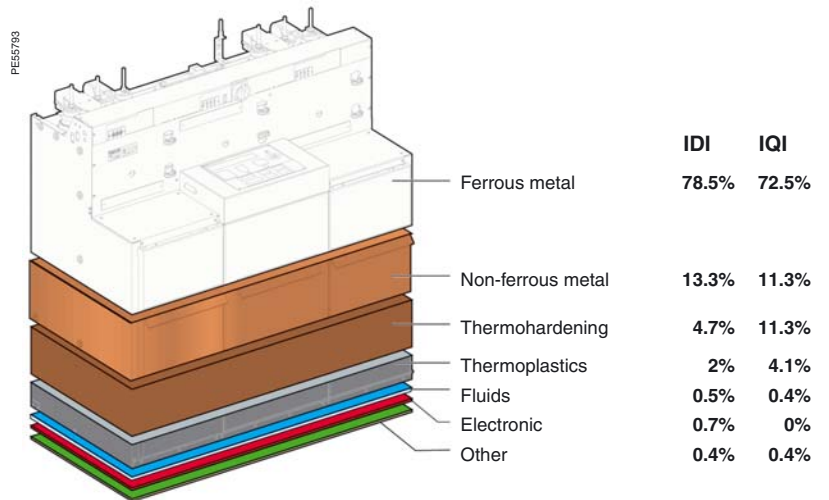

The environmental management system adopted by Schneider Electric production sites that produce the RM6 have been assessed and judged to be in conformity with requirements in the ISO 14001 standard.



IEC standards

RM6 is designed in accordance with the following standards:

General operation conditions for indoor switchgears

IEC 60694 (common specifications for high voltage switchgear and controlgear)

- Ambient temperature: class -25°C indoor
- lower than or equal to 40°C without derating
- lower than or equal to 35°C on 24 hours average without derating
- greater than or equal to -25°C.
- Altitude:
- lower than or equal to 1000 m
- above 1000 m, and up to 2000 m with directed field connectors
- greater than 2000 m: please consult us for specific precaution.

IEC 62271-200 (replacing IEC 60298): A.C. metal enclosed switchgear and controlgear for rated voltage above 1 kV and up to 52 kV)

- Switchgear classification: PM class (metallic partitioning)
- Loss of service continuity class: LSC2A
- Internal arc classification: class AF AL up to 20 kA / 1 s on request (access restricted to authorized personnel only, for front and lateral access).

Switch disconnectors

IEC 60265-1 (high voltage switches for rated voltage above 1 kV and up to 52 kV)

- Class M1/E3
- 100 CO cycles at rated current and 0.7 p.f.
- 1000 mechanical opening operations.

Circuit breakers: 200 A feeder or 630 A line protection

IEC 62271-100 (replacing IEC 60056: high voltage alternating current circuit breakers)

- Class M1/E2
- 2000 mechanical opening operations
- O-3 min.-CO-3 min.-CO cycle at rated short circuit current.

Other applicable standards

- Switch-fuse feeder: IEC 62271-105 (replacing IEC 60420): alternating current switch-fuse combination
- Earthing switch: IEC 62271-102 (replacing IEC 60129): alternating current disconnectors and earthing switches
- Electrical relays: IEC 60255.

A major plus point

Merlin Gerin has integrated a functional organization into each of its units, the main purpose of which is to check quality and ensure the adherence to standards.

This procedure is:

- the same throughout the different departments
- recognized by numerous approved customers and organizations.

Above all, it is our strict application of this functional organization that has enabled us to obtain the recognition of an independent organization, the French Association for Quality Assurance (Association Française pour l'Assurance Qualité, or **AFAQ**).

The RM6 design and production quality system has been certified as being in conformity with the requirements of the ISO 9001: 2000 quality assurance model.

Rigorous, systematic checks

During the manufacture of each RM6, it undergoes systematic routine tests, the aim of which is to check quality and conformity:

- tightness check
- filling pressure check
- opening and closing speed measurement
- operating torque measurement
- partial discharge check
- dielectric check
- conformity with drawings and diagrams.

The quality control department records and signs the results obtained on the **test certificate** for each device.

DE55745



05758



PE66413



RM6 switchgear comprises 1 to 4 integrated, low dimension functional units.

This self-contained, totally insulated unit comprises:

- a stainless steel, gas-tight metal enclosure, sealed for life, which groups together the live parts, switch-disconnector, earthing switch, fuse switch or the circuit breaker
- one to four cable compartments with interfaces for connection to the network or to the transformer
- a low voltage cabinet
- an electrical operating mechanism cabinet
- a fuse chamber compartment for fused switch-disconnectors or fuse switches.

The performance characteristics obtained by the RM6 meet the definition of a "sealed pressure system" laid down in the IEC recommendations.

The switch-disconnector and the earthing switch offer the operator all necessary usage guarantees:

Tightness

The enclosure is filled with SF6 at a 0.2 bar gauge pressure. It is sealed for life after filling. Its tightness, which is systematically checked at the factory, gives the switchgear an expected lifetime of 30 years. No maintenance of live parts is necessary with the RM6 breaking.

Switch disconnector

Electrical arc extinction is obtained using the SF6 puffer technique.

Circuit breaker

Electrical arc extinction is obtained using the rotating arc technique plus SF6 auto-expansion, allowing breaking of all currents up to the short-circuit current.

PE66428



A range that is extensible on site

When harsh climatic conditions or environmental restrictions make it necessary to use compact switchgear, but the foreseeable evolution of the power distribution network makes it necessary to provide for future changes, RM6 offers a range of extensible switchgear.

The addition of one or more functional units can be carried out by simply adding modules that are connected to each other at busbar level by directed field bushings. This very simple operation can be carried out on-site:

- without handling any gas
- without any special tooling
- without any particular preparation of the floor.

The only technical limitation to the evolution of an extensible RM6 switchboard is therefore the rated current acceptable by the busbar: 630 A at 40°C.

055749

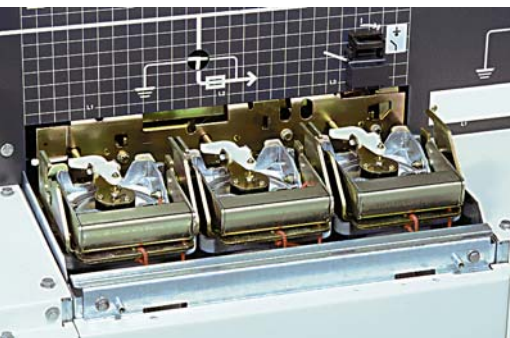

Insensitivity to the environment

Complete insulation

- **A metal enclosure** made of stainless steel, which is unpainted and gas-tight (IP67), contains the live parts of the switchgear and the busbars.
- **Three sealed fuse chambers**, which are disconnectable and metallized on the outside, insulate the fuses from dust, humidity...
- **Metallization of the fuse chambers and directed field terminal connectors** confines the electrical field in the solid insulation.

Taken together, the above elements provide the **RM6 with genuine total insulation** which makes the switchgear completely insensitive to environmental conditions, dust, extreme humidity, temporary soaking.

(IP67: immersion for 30 minutes, as laid down in IEC standard 60529, § 14.2.7).

DE57060EN



The RM6 is boosted by the DE-Mt module

This air-insulated cubicle is fitted with conventional current transformers and voltage transformers enabling invoicing of MV power. It has an internal arc withstand and is integrated in the RM6 unit by a direct connection to the adjacent busbars.

Increased environmental insensitivity

- By eliminating risks related to MV cables (incorrect connection, non-compliance with radius of curvature between two adjacent cubicles, etc.)
- Completely closed module (no opening to the bottom, no ventilation grid)
- Factory tested module.

A clear separation between MV and LV

Everything is done to avoid having to act on the MV compartment. The secondary of CT and VT's are cabled to the customer terminal in an LV compartment.

This LV compartment enables:

- connection to a remote power meter (in another room)
- or
- connection to the LV unit mounted on the LV compartment (option).

An LV unit adapted to your requirements

This unit allows the installation of active power meters, a reactive power meter, and all auxiliaries for monitoring current, voltage and consumed power.

The RM6 range



PE56428

PE56415

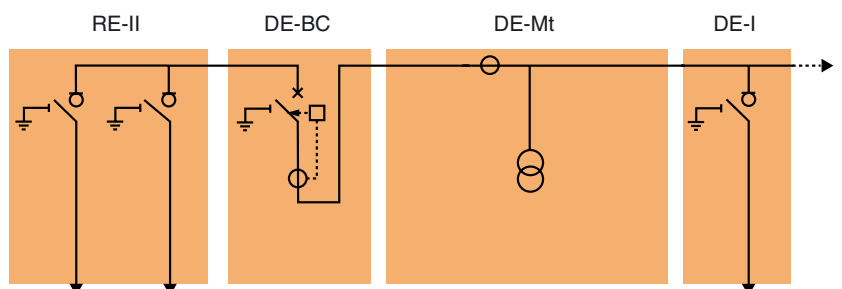

065750

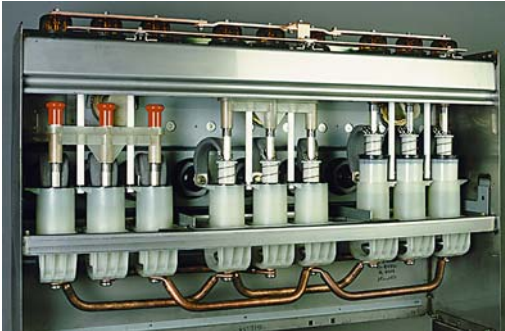

3 stable position switch

Switchgear

Switch-disconnectors and circuit breakers have similar architecture:

- a **moving contact assembly with 3 stable positions** (closed, open and earthed) moves vertically (see sketch). Its design makes simultaneous closing of the switch or circuit breaker and the earthing switch impossible.
- the **earthing switch** has a short-circuit making capacity, as required by the standards.
- the RM6 combines both the **isolating** and interrupting function.
- the earth collector has the correct dimensions for the network.
- access to the cable compartment can be interlocked with the earthing switch and/or the switch or circuit breaker.

PE56416

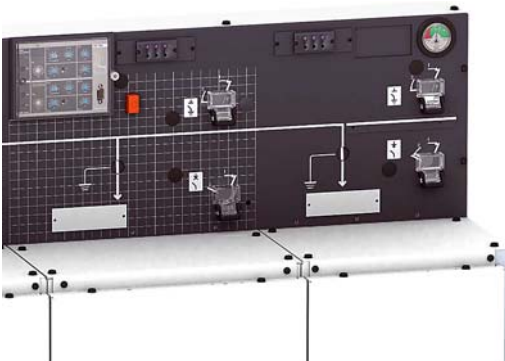

Reliable operating mechanisms

The electrical and mechanical operating mechanisms are located behind a front plate displaying the mimic diagram of the switchgear status (closed, open, earthed):

- **closing:** the moving contact assembly is manipulated by means of a fast-acting operating mechanism. Outside these manipulations, no energy is stored. For the circuit breaker and the fuse-switch combination, the opening mechanism is charged in the same movement as the closing of the contacts.
- **opening:** opening of the switch is carried out using the same fast-acting mechanism, manipulated in the opposite direction. For the circuit breaker and fuse-switch combination, opening is actuated by:
 - a pushbutton
 - a fault.
- **earthing:** a specific operating shaft closes and opens the earthing contacts. The hole providing access to the shaft is blocked by a cover which can be opened if the switch or circuit breaker is open, and remains locked when it is closed.
- **switchgear status indicators:** are placed directly on the moving contact assembly operating shafts. They give a definite indication of the position of the switchgear (attachment A of IEC standard 62271-102).
- **operating lever:** this is designed with an anti-reflex device which prevents any attempt to immediately reopen the switch-disconnector or the earthing switch after closing.
- **padlocking facilities:** 1 to 3 padlocks can be used to prevent:
 - access to the switch or circuit breaker operating shaft
 - access to the earthing switch operating shaft
 - operation of the opening pushbutton.

065746



Earthing display

- **Earthing switch closed position indicators:** these are located on the upper part of the RM6. They can be seen through the transparent earthing covers, when the earthing switch is closed.

065752



Internal arc withstand

The robust, reliable and environmentally insensitive design of the RM6 makes it highly improbable that a fault will appear inside the switchgear. Nevertheless, in order to ensure maximum personal safety, the RM6 is designed to withstand an internal arc supplied by a rated short-circuit current for 1 second, without any danger to the operator. Accidental overpressure due to an internal arc is limited by the opening of the safety valve, at the bottom of the metal enclosure. The gas is released to the rear or to the bottom of the RM6 without affecting conditions in the front. After type testing carried out for 16 kA 1 s and 20 kA 1 s, the device meets all the criteria of IAC class AF AL, as defined by **IEC 62271-200 standard, appendix A.**

055757



Operating safety

Cable insulation test

In order to test cable insulation or look for faults, it is possible to inject a direct current of up to 42 kVdc for 15 minutes through the cables via the RM6, without disconnecting the connecting devices.

The earthing switch is closed and the moving earthing connection is opened in order to inject the voltage via the “earthing covers”. This system, a built-in feature of the RM6, requires the use of injection fingers (supplied as an option).

PE56417



Voltage indicator lamps

A device (supplied as an option) on all functional units makes it possible to check the presence (or absence) of voltage in the cables.

Two types of indicator can be proposed according to network operating habits:

- a device with built-lamps, of the VPIS type (Voltage Presence Indicating System) complying with standard IEC 61958.

PE56418



- or a system with separate luminous modules, of the VDS type (Voltage Detection System) complying with standard IEC 61243-5.

RM6 range functions

The RM6 range brings together all of the MV functions enabling:

- connection, power supply and protection of transformers on a radial or open-ring network via **200 A circuit breakers** with an independent protection chain or via **combined fuse-switches**
- protection of lines by a **630 A circuit breaker**
- and now production of **private MV/LV substations** with MV metering.

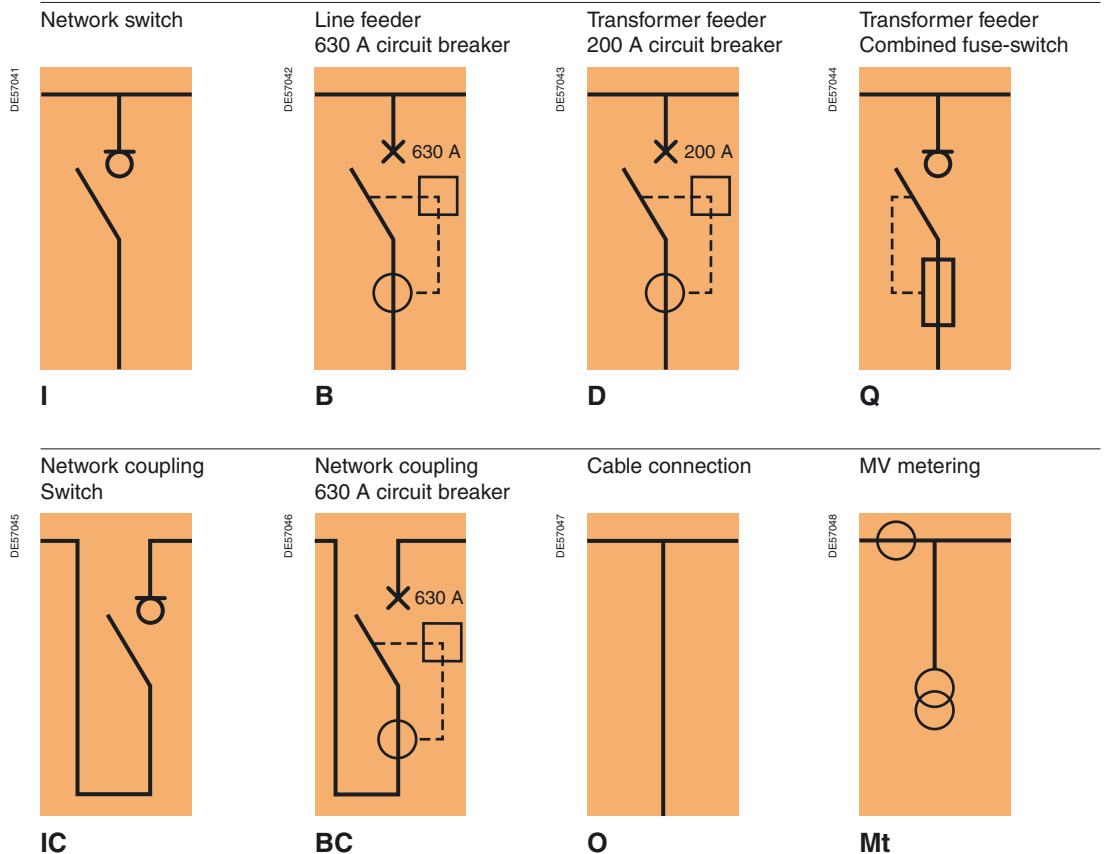

The RM6 range

Device designation

Type of tank

- NE**: non-extensible
- RE**: extensible to the right
- LE**: extensible to the left
- DE**: extensible module to the right or left (one function)

Multifunction configurations *

I B D Q	I	I B D Q	I
no. 4	no. 3	no. 2	no. 1

Unit configurations

I B D Q IC BC O Mt
no. 1

Examples of designations

RM6 NE-DIDI
RM6 RE-IDI
RM6 NE-IQI

RM6 DE-I
RM6 NE-D
RM6 DE-Mt

(*) Refer to the table on page 43 for the choice of different combinations

Electrical characteristics

Rated voltage	(kV)	12	17.5	24
Insulation level				
Industrial frequency	50 Hz 1 min (kV rms)	28	38	50
Impulse	1.2/50 μ s (kV peak)	75	95	125
Tank internal arc withstand	20 kA 1 s			

Climatic conditions

RM6 temperature	(°C)	40	45	50	55
Maximum rated current (A)	400 A version	400	400	400	355
	630 A version	630	575	515	460

Global options

- Manometer
- Additional earth busbar in cable compartment
- Internal arc cable box 20 kA 1 s for I and D or B functions.

Option for operation

Voltage indicator:

- VPIS
- VDS.

Accessories

- Raising plinth
- Set of 3 MV fuses Fusarc CF
- Phase comparator
- Test box for circuit breaker relay (VAP6)
- Additional operating handle.

Additional instructions:

Installation and civil Engineering instructions.

Connectors and adaptaters for RM6

- Connectors for 630 A (1 set = 1 function)
- Connectors for 400 A (1 set = 1 function)
- Connectors for 250 A (1 set = 1 function).

Protection index

IP3X on front face.

Network points with switch disconnecter (I function)

Rated voltage	(kV)	12	17.5	24	24	24	24
Short-time withstand current	(kA rms)	25	21	12.5	16	16	20
	Duration (s)	1	1 or 3	1	1	1	1 or 3
Network switch (I function)							
Rated current	(A)	630	630	400	400	630	630
Breaking capacity (A)	Charging current	630	630	400	400	630	630
	Earth leakage fault	95	95	95	95	95	95
	No-load cable	30	30	30	30	30	30
Making capacity of switch and earthing switches	(kA peak)	62.5	52.5	31.25	40	40	50
Bushing		C	C	B or C	B or C	C	C

Non-extensible switchgear

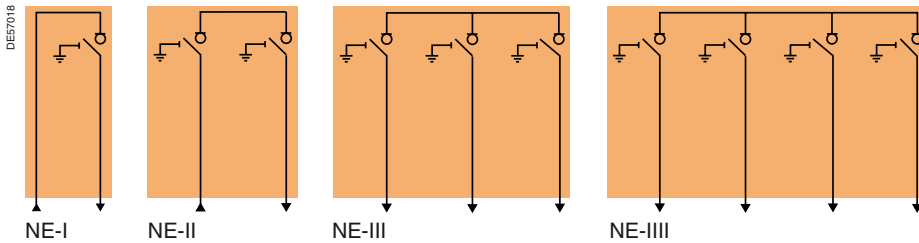

Extensible switchgear to the right

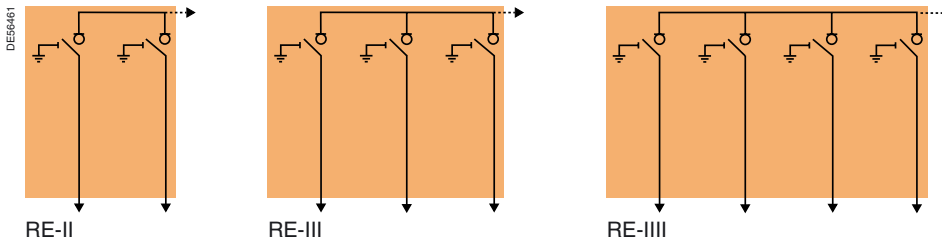

Accessories and options

Remote operation

Motor mechanism and auxiliary contacts LBSw 2 NO - 2 NC and ESw 1 O/C.

Auxiliary contacts alone

For main switch position indication 2 NO - 2 NC and ESw 1 O/C (this option is included in remote operation option).

Front door of cable connection compartment

- Bolted
- Removable with ESw interlocking
- Removable with ESw interlocking and LBSw interlocking.

Self-powered fault passage indicators

- Flair 21D
- Flair 21DT
- Flair 22D.

Key locking devices

- Type R1
- Type R2.

Network points with 630 A circuit breaker (B function)

Rated voltage	(kV)	12	17.5	24	24
Short-time withstand current	(kA rms)	25	21	16	20
	Duration (s)	1	1 or 3	1	1 or 3

Network switch (I function)

Rated current	(A)	630	630	630	630
Breaking capacity (A)	Charging current	630	630	630	630
	Earth leakage fault	95	95	95	95
	No-load cable	30	30	30	30
Making capacity of switch and earthing switches	(kA peak)	62.5	52.5	40	50
Bushing		C	C	C	C

Line protection feeder (B function)

Rated current	(A)	630	630	630	630
Short-circuit breaking capacity	(kA)	25	21	16	20
Making capacity	(kA peak)	62.5	52.5	40	50
Bushing		C	C	C	C

Unit characteristics

Non-extensible switchgear

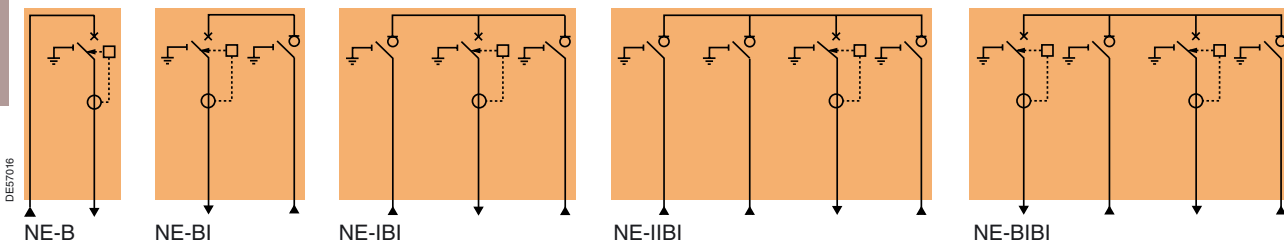

Extensible switchgear to the right

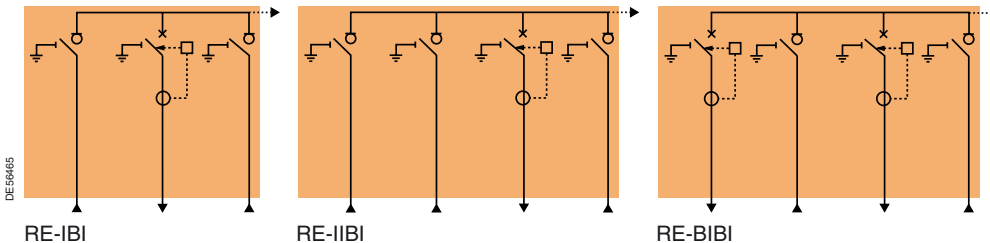

Accessories and options

Remote operation

Motor mechanism and auxiliary contacts CB
2 NO - 2 NC and ESw 1 O/C
(including shunt trip coil).

Auxiliary contacts alone

For main switch position indication
2 NO - 2 NC and ESw 1 O/C
(this option is included in remote operation option).

Front door of cable connection compartment

- Bolted
- Removable with ESw interlocking
- Removable with ESw interlocking and CB interlocking.

Shunt trip coil for external tripping

- 24 Vdc
- 48/60 Vdc
- 120 Vac
- 110/125 Vdc - 220 Vac
- 220 Vdc/380 Vac.

Undervoltage coil

- 24 Vdc
- 48 Vdc
- 125 Vdc
- 110-230 Vac.

Protection relay for CB transformer protection

(only one VIP type per unit)

Forbidden closing under fault 1 NC

Auxiliary contact D or B tripping

Key locking devices

- Type R1
- Type R2.

Transformer feeder 200 A with circuit breaker (D function)

Rated voltage	(kV)	12	17.5	24	24	24	24	24
Short-time withstand current	(kA rms)	25	21	12.5	16	12.5	16	20
	Duration (s)	1	1 or 3	1	1	1	1	1 or 3

Network switch (I function)

Rated current	(A)	630	630	400	400	630	630	630
Breaking capacity (A)	Charging current	630	630	400	400	630	630	630
	Earth leakage fault	95	95	95	95	95	95	95
	No-load cable	30	30	30	30	30	30	30
Making capacity of switch and earthing switches	(kA peak)	62.5	52.5	31.25	40	31.25	40	50
Bushing		C	C	B or C	B or C	C	C	C

Transformer feeder by circuit breaker (D function)

Rated current	(A)	200	200	200	200	200	200	200
Off-load transformer laking capacity	(A)	16	16	16	16	16	16	16
Short-circuit breaking capacity	(kA)	25	21	12.5	16	12.5	16	20
Making capacity	(kA peak)	62.5	52.5	31.25	40	31.25	40	40
Bushing		C	C	A	B or C	A	B or C	C

Non-extensible switchgear

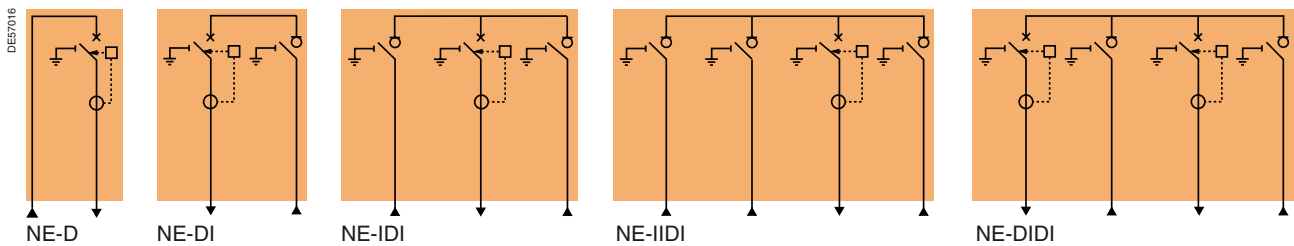

Extensible switchgear to the right

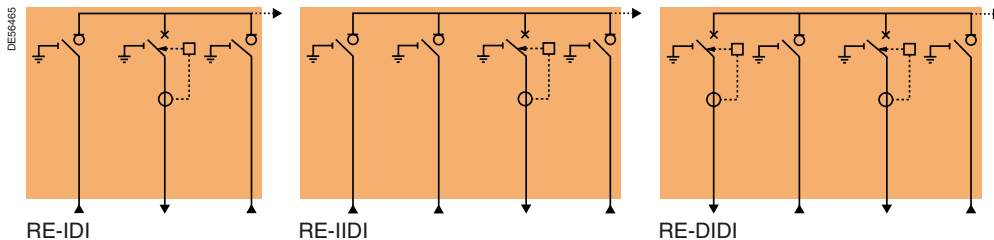

Accessories and options

Remote operation

Motor mechanism and auxiliary contacts CB
2 NO - 2 NC and ES w 1 O/C
(including shunt trip coil).

Auxiliary contacts alone

For main switch position indication
2 NO - 2 NC and ES w 1 O/C
(this option is included in remote operation option).

Front door of cable connection compartment

- Bolted
- Removable with ES w interlocking
- Removable with ES w interlocking and CB interlocking.

Shunt trip coil for external tripping

- 24 Vdc
- 48/60 Vdc
- 120 Vac
- 110/125 Vdc - 220 Vac
- 220 Vdc/380 Vac.

Undervoltage coil

- 24 Vdc
- 48 Vdc
- 125 Vdc
- 110-230 Vac.

Protection relay for CB transformer protection
(only one VIP type per unit)

Forbidden closing under fault 1 NC

Auxiliary contact D or B tripping

Key locking devices

- Type R6
- Type R7
- Type R8.

Transformer feeder with fuse-switch combinations (Q function)

Rated voltage	(kV)	12	12	17.5	24	24	24	24
Network switch (I function)								
Rated current	(A)	630	630	630	400	400	630	630
Breaking capacity (A)	Charging current	630	630	630	400	400	630	630
	Earth leakage fault	95	95	95	95	95	95	95
	No-load cable	30	30	30	30	30	30	30
Short-time withstand current	(kA rms)	21	25	21	12.5	16	16	20
	Duration (s)	1	1	1 or 3	1	1	1	1 or 3
Making capacity of switch and earthing switches	(kA peak)	52.5	62.5	52.5	31.25	40	40	50
Bushing		C	C	C	B or C	B or C	C	C

Transformer feeder with fuse-switch protection (Q function)

Rated current	(A)	200	200	200	200	200	200	200
Off-load transformer laking capacity	(A)	16	16	16	16	16	16	16
Short-circuit breaking capacity	(kA)	21	25	21	12.5	16	16	20
Making capacity	(kA peak)	52.5	62.5	52.5	31.25	40	40	50
Bushing		A	A	A	A	A	A	A

Non-extensible switchgear

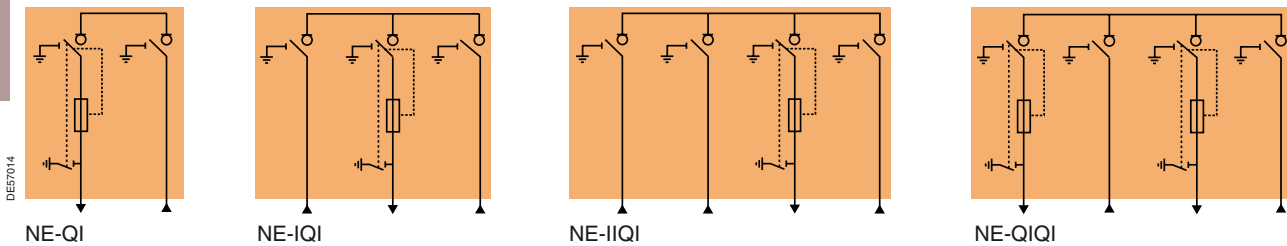

Extensible switchgear to the right

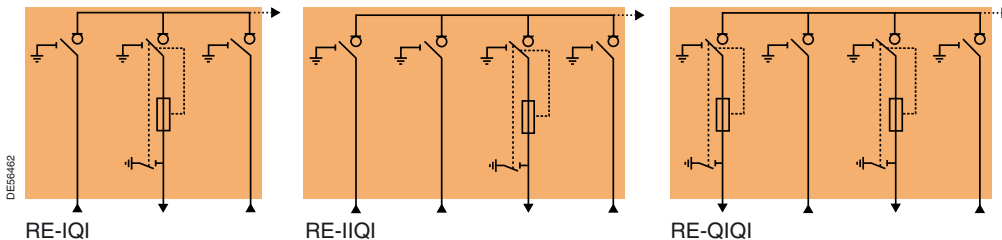

Accessories and options

Auxiliary contacts alone

For main switch position indication 2 NO - 2 NC and ESw 1 O/C (this option is included in remote operation option).

Auxiliary contact for fuses blown

Shunt trip coil for external tripping

- 24 Vdc
- 48/60 Vdc
- 120 Vac
- 110/125 Vdc - 220 Vac
- 220 Vdc/380 Vac.

Undervoltage coil

- 24 Vdc
- 48 Vdc
- 125 Vdc
- 110-230 Vac.

Key locking devices

- Type R6
- Type R7
- Type R8.

Extensible modules (DE-I function)

Rated voltage	(kV)	12	17.5	24	24	24	24
Short-time withstand current	(kA rms)	25	21	12.5	16	16	20
	Duration (s)	1	1 or 3	1	1	1	1 or 3
Network switch (DE-I function)							
Rated current (busbar 630 A)	(A)	630	630	400	400	630	630
Breaking capacity (A)	Charging current	630	630	400	400	630	630
	Earth leakage fault	95	95	95	95	95	95
	No-load cable	30	30	30	30	30	30
Making capacity of switch and earthing switches	(kA peak)	62.5	52.5	31.25	40	40	50
Bushing		C	C	B or C	B or C	C	C

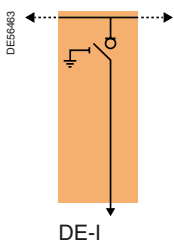

Accessories and options

Remote operation

Motor mechanism and auxiliary contacts LBSw
2 NO - 2 NC and ESw 1 O/C

Auxiliary contacts alone

For main switch position indication
2 NO - 2 NC and ESw 1 O/C
(this option is included in remote operation option).

Front door of cable connection compartment

- Bolted
- Removable with ESw interlocking
- Removable with ESw interlocking and LBSw interlocking.

Self-powered fault passage indicators

- Flair 21D
- Flair 21DT
- Flair 22D.

Arc short-circuiting device

Key locking devices

- Type R1
- Type R2.

Network points with 630 A circuit breaker (DE-B function)

Rated voltage	(kV)	12	17.5	24	24
Short-time withstand current	(kA rms)	25	21	16	20
	Duration (s)	1	1 or 3	1	1 or 3
Network circuit breaker (DE-B function)					
Rated current (busbar 630 A)	(A)	630	630	630	630
Short-circuit breaking capacity	(kA)	25	21	16	20
Making capacity	(kA peak)	62.5	52.5	40	40
Bushing		C	C	C	C

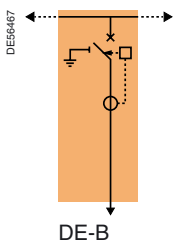

Accessories and options

Remote operation

Motor mechanism and auxiliary contacts CB
2 NO - 2 NC and ESw 1 O/C
(including shunt trip coil).

Auxiliary contacts alone

For main switch position indication
2 NO - 2 NC and ESw 1 O/C
(this option is included in remote operation option).

Front door of cable connection compartment

- Bolted
- Removable with ESw interlocking
- Removable with ESw interlocking and CB interlocking.

Shunt trip coil for external tripping

- 24 Vdc
- 48/60 Vdc
- 120 Vac
- 110/125 Vdc - 220 Vac
- 220 Vdc/380 Vac.

Undervoltage coil

- 24 Vdc
- 48 Vdc
- 125 Vdc
- 110-230 Vac.

Protection relay for CB transformer protection
(only one VIP type per unit)

Forbidden closing under fault 1 NC

Auxiliary contact D or B tripping

Key locking devices

- Type R1
- Type R2.

Transformer feeder 200 A with circuit breaker (DE-D function)

Rated voltage	(kV)	12	17.5	24	24	24
Short-time withstand current	(kA rms)	25	21	12.5	16	20
	Duration (s)	1	1 or 3	1	1	1 or 3
200 A circuit breaker (DE-D function)						
Rated current (busbar 630 A)	(A)	200	200	200	200	200
Off-load transformer laking capacity	(A)	16	16	16	16	16
Short-circuit breaking capacity	(kA)	25	21	12.5	16	20
Making capacity	(kA peak)	62.5	52.5	31.25	40	50
Bushing		C	C	A	B or C	C

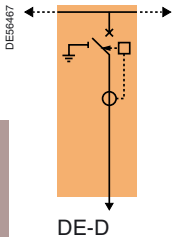

Accessories and options

Remote operation

Motor mechanism and auxiliary contacts
CB 2 NO - 2 NC and ESw 1 O/C
(including shunt trip coil).

Auxiliary contacts alone

For main switch position indication
2 NO - 2 NC and ESw 1 O/C
(this option is included in remote operation option).

Front door of cable connection compartment

- Bolted
- Removable with ESw interlocking
- Removable with ESw interlocking and CB interlocking.

Shunt trip coil for external tripping

- 24 Vdc
- 48/60 Vdc
- 120 Vac
- 110/125 Vdc - 220 Vac
- 220 Vdc/380 Vac.

Undervoltage coil

- 24 Vdc
- 48 Vdc
- 125 Vdc
- 110-230 Vac.

Protection relay for CB transformer protection

(only one VIP type per unit)

Forbidden closing under fault 1 NC

Auxiliary contact D or B tripping

Key locking devices

- Type R6
- Type R7
- Type R8.

Extensible modules (DE-Q function)

Rated voltage	(kV)	12	12	17.5	24	24	24
Fuses (DE-Q function)							
Rated current (busbar 630 A)	(A)	200	200	200	200	200	200
Off-load transformer laking capacity	(A)	16	16	16	16	16	16
Short-circuit breaking capacity	(kA)	21	25	21	12.5	16	20
Making capacity	(kA peak)	52.5	62.5	52.5	31.25	40	50
Bushing		A	A	A	A	A	A

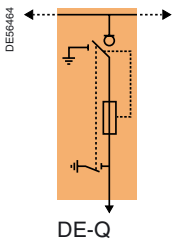

Accessories and options

Auxiliary contacts alone

For main switch position indication
2 NO - 2 NC and ESw 1 O/C
(this option is included in remote operation option).

Auxiliary contact for fuses blown

Shunt trip coil for external tripping

- 24 Vdc
- 48/60 Vdc
- 120 Vac
- 110/125 Vdc - 220 Vac
- 220 Vdc/380 Vac.

Undervoltage coil

- 24 Vdc
- 48 Vdc
- 125 Vdc
- 110-230 Vac.

Key locking devices

- Type R6
- Type R7
- Type R8.

Bus sectionalizer by load-break switch (DE-IC function)

Rated voltage	(kV)	12	17.5	24	24
Short-time withstand current	(kA rms)	25	21	16	20
	Duration (s)	1	1 or 3	1	1 or 3
Network switch (DE-IC function)					
Rated current	(A)	630	630	630	630
Breaking capacity (A)	Charging current	630	630	630	630
	Earth leakage fault	95	95	95	95
	No-load cable	30	30	30	30
Making capacity of switch and earthing switches	(kA peak)	62.5	52.5	40	50

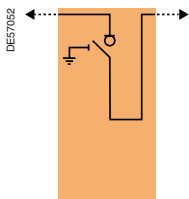

DE-IC

Accessories and options

Remote operation

Motor mechanism and auxiliary contacts LBSw
2 NO - 2 NC and ESw 1 O/C

Auxiliary contacts alone

For main switch position indication
2 NO - 2 NC and ESw 1 O/C
(this option is included in remote operation option).

Front access door for current sensors

- Bolted
- Removable with ESw interlocking
- Removable with ESw interlocking and LBSw interlocking.

Arc short-circuiting device

Without earthing switch

Key locking devices

- Type R1
- Type R2.

Bus sectionalizer by 630 A circuit breaker (DE-BC function coupling)

Rated voltage	(kV)	12	17.5	24	24
Short-time withstand current	(kA rms)	25	17.5	16	24
	Duration (s)	1	1 or 3	1	1 or 3
Bus sectionalizer circuit breaker (DE-BC function coupling)					
Rated current	(A)	630	630	630	630
Short-circuit breaking capacity	(kA)	25	21	16	20
Making capacity	(kA peak)	62.5	52.5	40	50

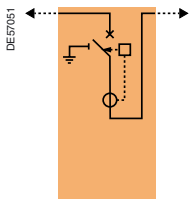

DE-BC

Accessories and options

Remote operation

Motor mechanism and auxiliary contacts CB
2 NO - 2 NC and ESw 1 O/C
(including shunt trip coil).

Auxiliary contacts alone

For main switch position indication
2 NO - 2 NC and ESw 1 O/C
(this option is included in remote operation option).

Front door of cable connection compartment

- Bolted
- Removable with ESw interlocking
- Removable with ESw interlocking and CB interlocking.

Shunt trip coil for external tripping

- 24 Vdc
- 48/60 Vdc
- 120 Vac
- 110/125 Vdc - 220 Vac
- 220 Vdc/380 Vac.

Undervoltage coil

- 24 Vdc
- 48 Vdc
- 125 Vdc
- 110-230 Vac.

Protection relay for CB transformer protection
(only one VIP type per unit)

Forbidden closing under fault 1 NC

Auxiliary contact D or B tripping

Without earthing switch

Key locking devices

- Type R1
- Type R2.

Cable connection cubicles LE-O, RE-O, DE-O

Rated voltage	(kV)	12	12	17.5	17.5	24	24	24
Cable connection (O function)								
Rated current	(A)	200	630	200	630	200	630	630
Short-circuit breaking capacity	(kA)	25	25	21	21	16	16	20
Short-time withstand current	(kA rms)	25	25	21	21	16	16	20
	Duration (s)	1	1	3	3	1	1	1 or 3
Making capacity	(kA peak)	62.5	62.5	52.5	52.5	40	40	50
Bushing		C	C	C	C	C	C	C

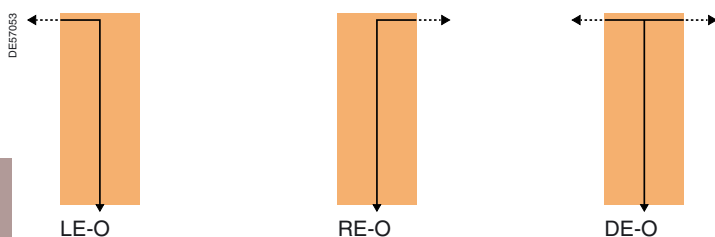

Unit characteristics

Metering module DE-Mt

Rated voltage	(kV)	12	17.5	24	24
MV metering (DE-Mt function)					
Rated current	(A)	630	630	630	630
Short-time withstand current	(kA rms)	25	21	16	20
	Duration (s)	1	1 or 3	1	1 or 3
Cubicle internal arc withstand	16 kA 1s				

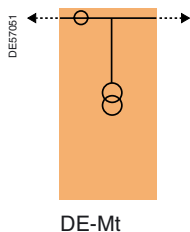

Voltage transformers configuration

Merlin Gerin models or DIN 42600 type section 9
 2 phase-phase VT, 2 phase-earth VT, 3 phase-earth VT
 Fitted right or left of the CT's
 Optional fuse protection.

Current transformers configuration

Merlin Gerin models or DIN 42600 type section 8
 2 CT or 3 CT.

Accessories and options

- Additional low voltage unit
- Door key locking devices
- Type R7.

Line protection by a 630 A circuit breaker

064477



VIP 300

The 630 A circuit breaker has been designed to protect Medium Voltage feeders as near to the fault as possible. The protection unit is identical to that of the 200 A circuit breaker, with a VIP 300 relay adapted to network protection.

VIP 300 self-powered protection relay

- VIP 300 protects against phase to phase faults and earth faults. The choice of tripping curves, and the multiplicity of settings enable it to be used with a wide variety of discrimination plans.
- VIP 300 is a self-powered relay which obtains its power supply from current sensors. It does not need an auxiliary power supply. It actuates a release.

Description

The operating principle of the protection unit is the same as for the VIP 30 and VIP 35 relays.

Phase protection

Phase protection has two independently adjustable set points:

- either an IDMT or definite low set point can be selected. The IDMT curves are in conformity with the IEC 60255-3 standard. They are of the inverse, very inverse and extremely inverse type
- the high set point is a definite time one.

Earth protection

- Earth fault protection operates with measurement of the residual current carried out using the sum of the secondary currents of the sensors.
- As with phase protection, earth protection has two independently adjustable set points.

Indication

- Two indicators show the origin of tripping (phase or earth). They remain in position after the relay power supply is cut off.
- Two LED indicators (phase and earth) indicate that the low set point has been exceeded and its time delay is in progress.

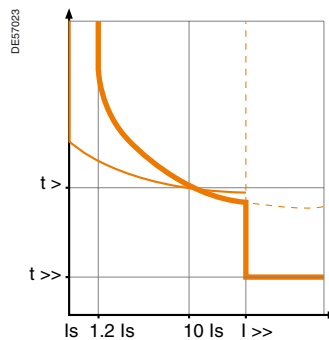

With IDMT low set point

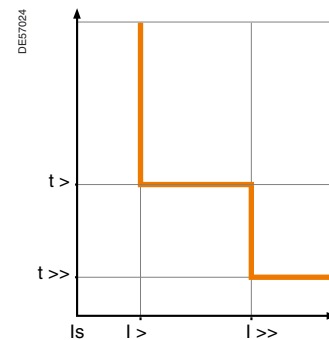

With definite time low set point

Unit characteristics

- The curves in this chapter indicate the low set IDMT tripping times for time delay settings $t >$ (or to $>$).
- The phase protection and earth protection curves are identical.

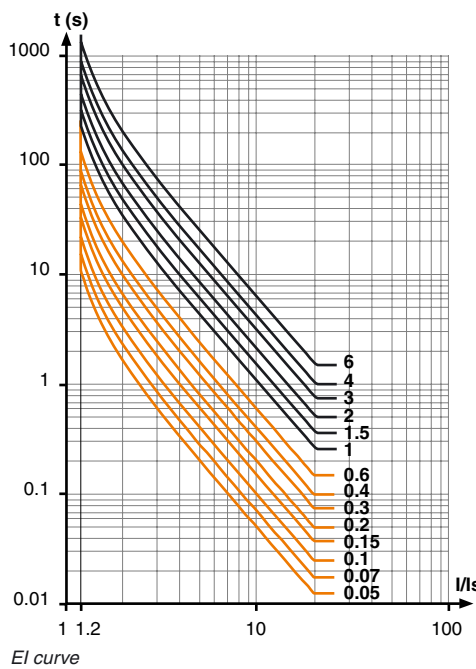
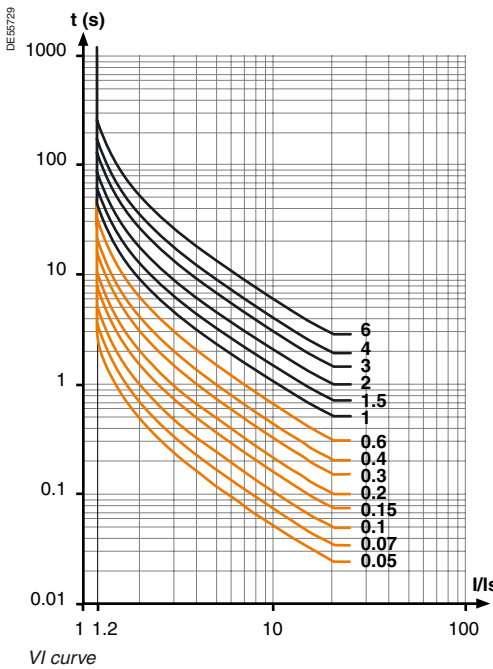
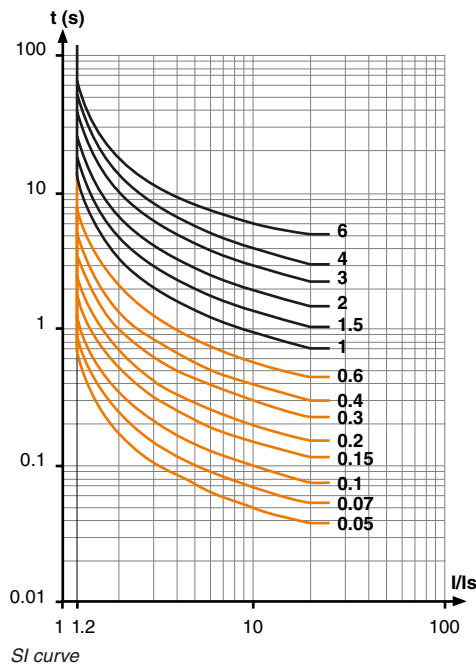
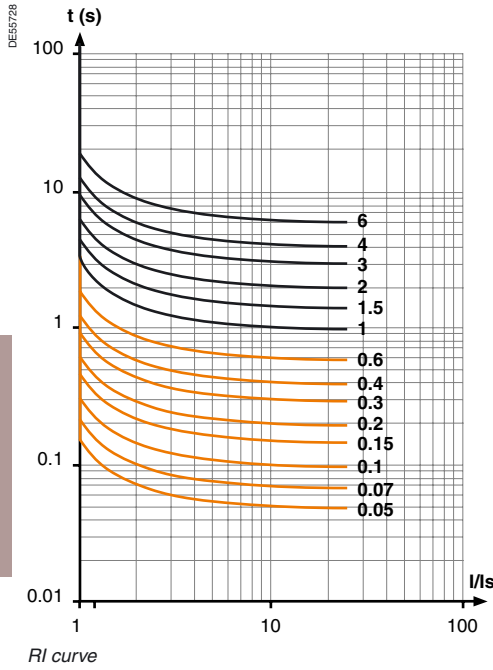

Transformer protection by a 200 A circuit breaker

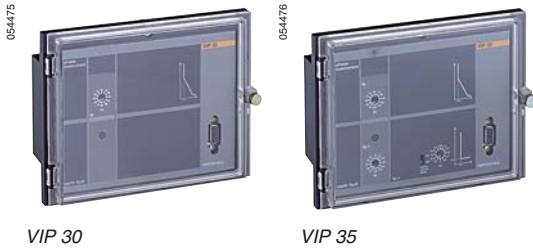

In contrast to fuses, the circuit breaker has no minimum breaking current, which means that it is particularly well-adapted to transformer protection.

Protection system

The protection system operates without an auxiliary power supply, and includes:

- 3 transformers with integrated toroids on the transformer feeder bushings
- 1 VIP 30 or VIP 35 electronic relay
- 1 release
- 1 test connector to check whether the protection unit is operating correctly, using the VAP 6 unit.

VIP 30 and VIP 35 self-powered protection relays

- VIP 30 and VIP 35 are self-powered relays, requiring no auxiliary power supply, which are fed by current sensors, activating a MITOP release.
- VIP 30 protects against phase to phase faults.
- VIP 35 protects against phase to phase faults and earth faults.

Description

- The relays are assembled in a housing, and the front faces are protected a transparent cover. The whole assembly has a degree of protection of IP54
- Settings are made on the front, using rotary switches
- The phase operating current is adjusted directly according to the transformer rating and the operating voltage
- The earth current set point is adjusted according to the network characteristics.

Phase protection

- Phase protection is provided by an IDMT set point which operates as of 1.2 times the operating current (I_s). VIP 30 and VIP 35 phase protections are identical.

Earth protection

- Earth fault protection operates with measurement of the residual current carried out using the sum of the secondary currents of the sensors
- Earth protection operates in definite time: both its set point and time delay are adjustable.

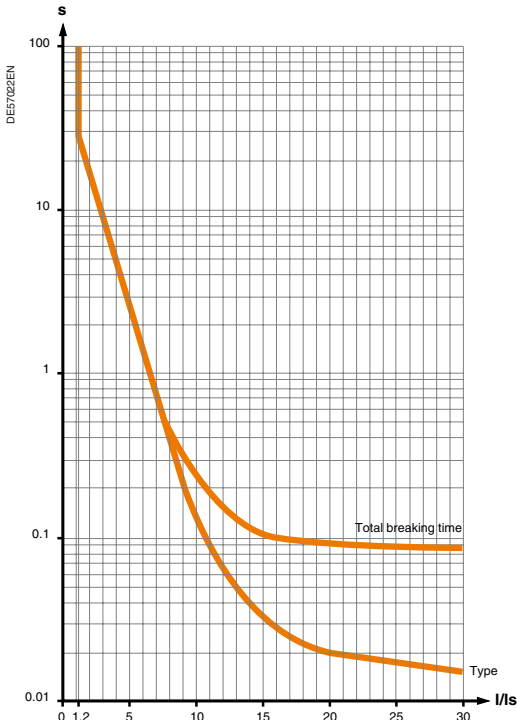

The curve represent the relay intervention time, to which 70 ms must be added to obtain the breaking time..

Rated protection current setting selection

Operating voltage (kV)	Transformer rating (kVA)																Rated voltage (kV)			
	50	75	100	125	160	200	250	315	400	500	630	800	1000	1250	1600	2000		2500	3000	
3	10	15	20	25	36	45	55	68	80	140	140	170	200							12
3.3	10	15	18	22	28	36	45	56	70	90	140	140	200							
4.2	8	12	15	18	22	28	36	45	56	70	90	140	140	200						
5.5		8	12	15	18	22	28	36	46	55	68	90	140	140	200					
6			10	12	18	20	25	36	46	55	68	80	140	140	200	200				
6,6			10	12	15	18	22	28	36	45	56	70	90	140	140	200				
10				8	10	12	15	20	25	30	37	55	68	80	140	140	170	200		
11					10	12	15	18	22	28	36	45	55	68	90	140	140	170		
13.8					8	10	12	15	18	22	28	36	46	55	68	90	140	140	170	24
15						8	10	15	18	20	25	36	45	55	68	80	140	140		
20							8	10	15	20	25	30	37	45	55	68	80	140		
22								8	10	12	15	18	22	28	36	45	55	68	80	

Transformer protection by fuse-switches

Fuse replacement

IEC and UTE recommendations stipulate that when a fuse has blown, **all three fuses must be replaced.**

Ratings for fuses for transformer protection depend, among other points, on the following criteria:

- service voltage
- transformer rating
- thermal dissipation of the fuses
- fuse technology.

Two types of fuse may be installed:

- **Solefuse type:** according to UTE NFC 64210 standard, with or without striker,
- **Fusarc CF type:** according to IEC 60282-1 dimensional standard, with or without striker.

Example (using the selection table below) general case, for protection of a 400 kVA transformer at 10 kV, either **Solefuse** fuses with a rating of 63 A or **Fusarc CF** fuses with a rating of 50 A are chosen.

Correct operation of the RM6 is not guaranteed when using fuses from other manufacturers.

Selection table

(Rating in A, no overload, $-25^{\circ}\text{C} < \theta < 40^{\circ}\text{C}$)

Fuse type	Operating voltage (kV)	Transformer rating (kVA)													Rated voltage (kV)				
		50	75	100	125	160	200	250	315	400	500	630	800	1000		1250	1600	2000	
Solefuse (UTE NFC standards: 13.100, 64.210)																			
	5.5	16		31.5	31.5	63	63	63	63	63									7.2
	10			16	16	31.5	31.5	31.5	63	63	63	63							24
	15			16	16	16	16	16	43	43	43	43	43	63					
	20			16	16	16	16	16	16	43	43	43	43	63					
Fusarc CF and SIBA ⁽¹⁾ (General case, IEC 60282-1 standard, IEC 62271-105 (to replace IEC 60420) and DIN 43625 standard)																			
	3	20	31.5	40	50	50	63	80	100	125 ⁽²⁾	160 ⁽¹⁾								12
	3.3	20	25	40	40	40	63	80	80	125 ⁽²⁾	125 ⁽²⁾	160 ⁽¹⁾							
	4.2	20	25	25	40	50	50	63.5	80	80	100	125 ⁽²⁾	160 ⁽¹⁾						
	5.5	16	20	25	25	40	40	50	63	80	80	100	125 ⁽²⁾	160 ⁽¹⁾					
	6	16	20	25	25	31.5	40	50	50	63	80	100	125 ⁽²⁾	160 ⁽¹⁾					
	6.6	10	20	25	25	31.5	40	50	50	63	63	80	100	125 ⁽²⁾	160 ⁽¹⁾				
	10	10	10	16	20	25	25	31.5	40	50	50	63	80	100	125 ⁽²⁾				
	11	10	10	16	20	20	25	25	40	40	50	50	63	80	100	125 ⁽²⁾			
	13.8	10	10	10	16	16	20	25	31.5	40	40	50	50	63	100 ⁽²⁾				24
	15	10	10	10	10	16	20	25	31.5	31.5	40	50	50	63	80	100 ⁽²⁾			
	20	10	10	10	10	16	16	20	25	25	31.5	40	40	63	63	80	100 ⁽²⁾		
	22	10	10	10	10	10	16	16	20	25	31.5	40	40	50	63	80	100 ⁽²⁾		

⁽¹⁾ Siba type fuses at 160 A/12 kV reference 30-020-13

⁽²⁾ In the case of an external trip system (e.g.: overcurrent relay)

A calculation must be carried out to guarantee coordination of fuse-switches – Please consult us.

For any values not included in the table, please consult us.

In the case of an overload beyond 40°C, please consult us.

Fuse dimensions

Solefuse

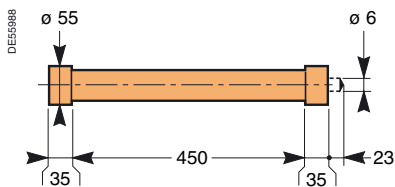

Ur (kV)	I _r (A)	L (mm)	Ø (mm)	Mass (kg)
7.2	16 to 63	450	55	2
24	16 to 63	450	55	2

Fusarc CF

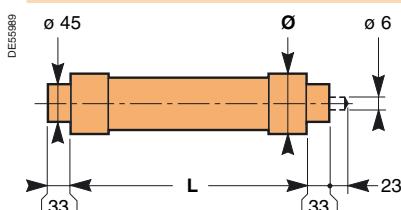

Ur (kV)	I _r (A)	L (mm)	Ø (mm)	Mass (kg)
12	10 to 20	292	50.5	1.2
	25 to 40	292	57	1.5
	50 to 100	292	78.5	2.8
24	10 to 20	442	50.5	1.6
	25 to 40	442	57	2.2
	50 to 63	442	78.5	4.1
	80 to 100	442	88	5.3

Continuity of service guaranteed by an overall telecontrol offer

Schneider Electric offers you a complete solution, including:

- the Easergy T200 I telecontrol interface
- MV switchgear that is adapted for telecontrol.

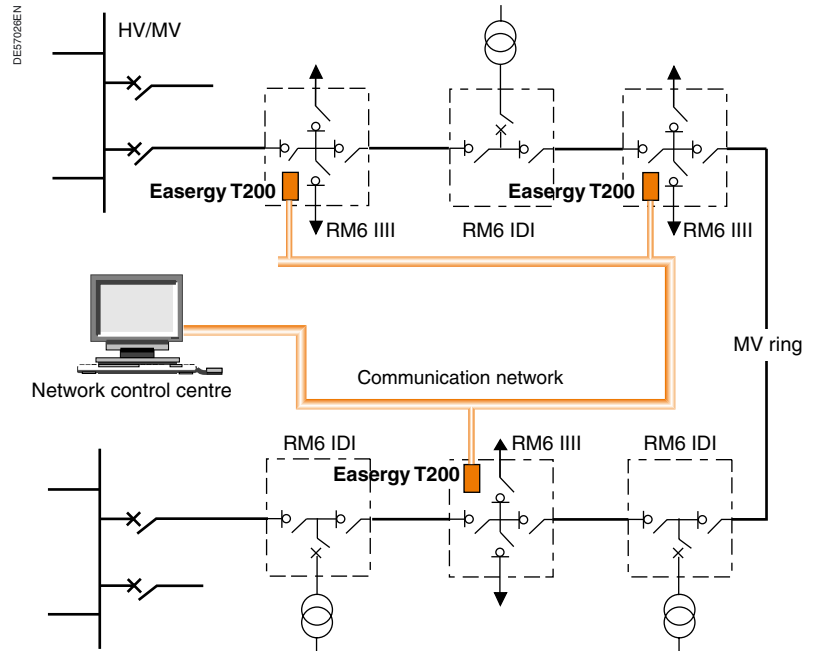

Position of the RM6

RM6 switchgear is perfectly adapted to the telecontrol context, thanks to options such as:

- Easergy T200 I telecontrol interface
- electrical rating mechanism
- auxiliary fault and position indication contacts
- current sensors for fault detection.



PE68311

Easergy T200 I: an interface designed for telecontrol of MV networks

Easergy T200 I is a “plug and play” or multifunction interface that integrates all the functional units necessary for remote supervision and control of the RM6:

- acquisition of the different types of information: switch position, fault detectors, current values...
- transmission of switch open/close orders
- exchanges with the control center.

Required particularly during outages in the network, Easergy T200 I is of proven reliability and availability, being able to ensure switchgear operation at any moment. It is simple to set up and to operate.



PE6421

Local information and control



PE6422

Monitoring and control

Functional unit designed for the Medium Voltage network

- Easergy T200 I is designed to be connected directly to the MV switchgear, without requiring a special converter.
- It has a simple front plate for local operation, which allows management of electrical rating mechanisms (local/remote switch) and display of information concerning switchgear status.
- It has an integrated MV network fault current detection system (overcurrent and zero sequence) with detection set points that can be configured channel by channel (current value and fault current duration).



PE6423

Back up power supply



PE6306

Polarized connectors

Medium Voltage switchgear operating guarantee

- Easergy T200 I has undergone severe MV electrical stress withstand tests.
- It is a backed up power supply which guarantees continuity of service for several hours in case of loss of the auxiliary source, and supplies power to the Easergy T200 I and the MV switchgear motor mechanisms.
- **Ready to plug**
 - Easergy T200 I is delivered with a kit that makes it easy to connect the motor mechanisms and collect measurements.
 - the telecontrol cabinet connectors are polarized to avoid any errors during installation or maintenance interventions.
 - current measurement acquisition sensors are of the split type, to facilitate their installation.
 - works with 24 Vdc and 48 Vdc motor units.



61021N

Split sensors

055748

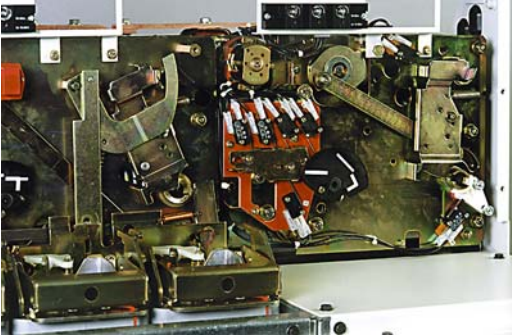

Motor mechanism

Switch operating mechanism

- The switch operating mechanism includes a space that is reserved for the installation of a geared motor. This can be installed at the factory, but it can also be installed on-site, by the customer, without de-energizing the unit, and without dismantling the operating mechanism.
- An electrical interlocking assembly prohibits any false operations. Once motorized, the RM6 integrates perfectly into a telecontrol system.

055807

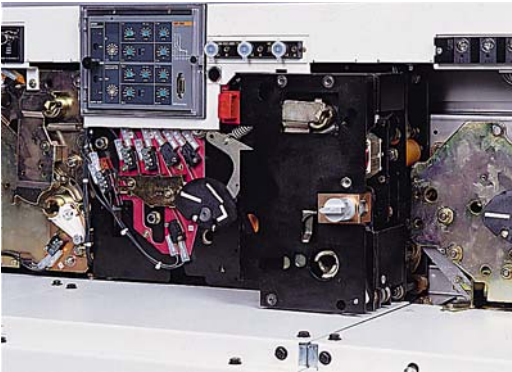

Circuit breaker operating mechanism

- Circuit breaker protection functional units can be equipped with a geared motor. This can be installed at the factory, but it can also be installed on-site, by the customer, without de-energizing the unit, and without dismantling the operating mechanism.
 - Electrical locking prohibits any false operations, with, as an option, closing after an unacknowledged fault. Once motorized, the RM6 integrates perfectly into a telecontrol system.
- This option becomes particularly useful in the context of the protection of a secondary ring, with supervision by a telecontrol system.

Motor option for switch-units and circuit breakers

The operating mechanism I, D and B functions may be motorised

	DC						AC (50 Hz) *	
Un power supply (V)	24	48	60	110	125	220	120	230
Power	(W)							
	(VA)						280	
Arming time (s)	4 to 7						4 to 7	

(*) Please consult us for other frequencies.

055748B

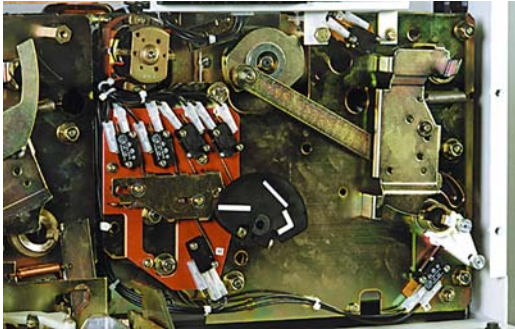

Auxiliary contacts

Each switch or circuit breaker can be fitted with 4 auxiliary contacts with the following positions: 2 NO and 2 NC.
 Each earthing switch can be fitted with 1 auxiliary contact with the following position: (opening/closing).
 Each circuit breaker can be fitted with 1 fault indication auxiliary contact.
 Each fuse-switch combination can be fitted with 1 blown fuse indication auxiliary contact.

055747

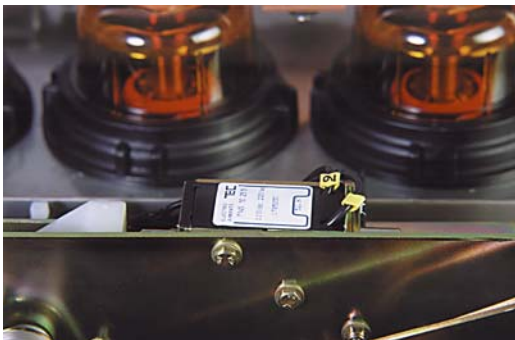

Opening release

Each circuit breaker or fuse-switch combination can be fitted a switch-on opening release (shunt trip).

Opening release option for each circuit breaker or fuse-switch combination

		DC						AC (50 Hz) *	
Un power supply	(V)	24	48	60	110	125	220	120	230
Power	(W)	200	250	250	300	300	300		
	(VA)							400	750
Response time	(ms)	35						35	

(*) Please consult us for other frequencies.

Accessories

PE56924

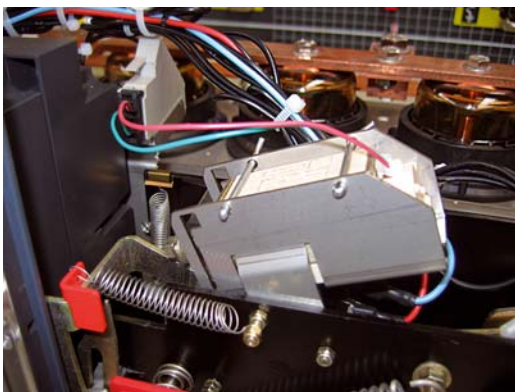

Undervoltage coil

Available on the circuit breaker function and on the combined fuse-switch, this trip unit causes opening when its supply voltage drops below a value under 35% of its rated voltage.

		DC						AC (50 Hz) *		
Un power supply	(V)	24	48	60	110	125	220	120	230	
Power										
	Excitation	(W or VA)	200 (during 200 ms)						200	
	Latched	(W or VA)	4.5						4.5	
Threshold										
	Opening		0.35 to 0.7 Un						0.35 to 0.7	
	Closing		0.85 Un						0.85	

(*) Please consult us for other frequencies.



Flair 21D and 21 DT



Flair 22 D

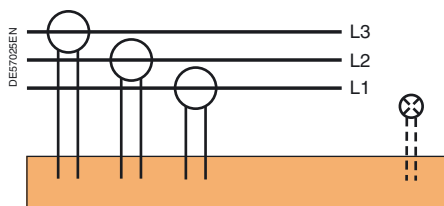

21D

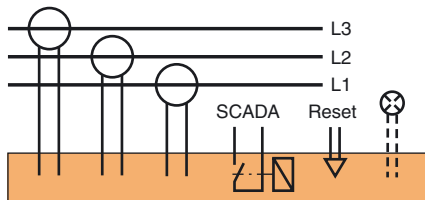

21DT

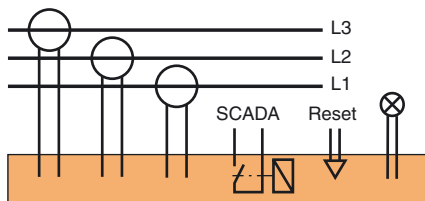

22D

Fault current indicator

RM6 switchboard integrate fault passage indicators, on every switch function: Flair 21D, Flair 21DT, Flair 22D (*).

These FPI are self-powered by the sensors and comprise a digital display.

They provide:

- earth fault indication
- phase fault indication
- load current display (Ampermeter).

(*) RM6 can also be provided with Alpha M or Alpha E (Hortzmann) type short circuit indicators.

Connection

	21D	21DT	22D
Fault detection			
Earth fault	20 to 160 A	20 to 160 A	20 to 160 A
Phase fault	20 to 160 A		
Reset	■	■	■
SCADA interface		■	■
Display unit			
Display	2 digits	2 digits	4 digits
Load current	10 A	10 A	1 A
Accuracy	10%	10%	10%
Settings	■	■	■
Faulty phase	■	■	■
Frequency			■
Peak demand current			■
Load current demand			■
Others			
Dual-powered (sensor and battery)			■
External light	■	■	■

Flair 21D and Flair 21DT operate with a load current more than 3 A.

Due to a lithium battery, Flair 22D operates with no load current (setting display, reset temporisation > 4 h).

PE56417



Voltage presence indicator

There is a voltage indicator device on network switches, circuit breakers and fuse-switch combinations, which makes it possible to check whether or not there is a voltage across the cables.

Two devices are offered:

- VDS: Voltage Detecting System
- VPIS: Voltage Presence Indication System.

045780



Phase concordance unit

This unit is used to check phase concordance. It can be connected to any voltage indicator lamp device.

095814



Protection relay test

The portable VAP 6 unit is connected to the circuit breaker protection relay:

- injecting an electrical stimulus, two pushbuttons are used to check that the short-circuit and zero sequence fault current protection devices are operating
- an extra pushbutton may be provided to inhibit tripping of the circuit breaker.

Accessories

PE56425



Options for cable compartment

Standard equipment:

- a closing panel
- cable binding
- connection of cable earthing.

Optional equipment:

- panel with hood to display liquid type overcurrent indicators installed around the cables
- deeper panel to enable to adding of a lightning arrester
- interlocking to prohibit access to the connection compartment when the earthing switch is open
- interlocking to prohibit closing of the switch or circuit breaker when the connection compartment panel is open
- compartment base for single-core or three-core cables (compulsory for non-directive field connections)
- internal arc withstand for the cable compartment up to 20 kA 1s.

MT55154



The markings (O, S, and X) are engraved on the keys and the locks. They are given here only as an aid to understanding of the diagrams.

Type R1 diagram

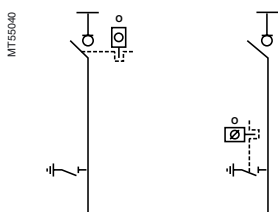

Type R2 diagram

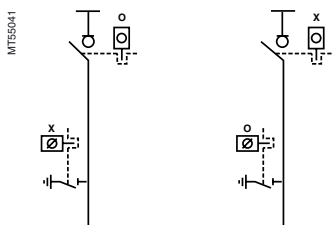

On network switches or 630 A circuit breaker feeder

Semi-crossed locking

■ Prohibits the closing of the earthing switch of the downstream switchgear unless the upstream switchgear is locked in the “open” position.

Crossed locking

■ Prohibits closing of the earthing switches unless the upstream and downstream switchgear is locked in the “open” position.

Type R7 diagram

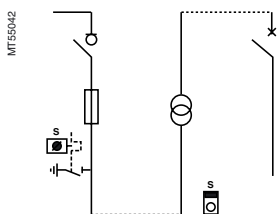

On transformer feeders

RM6/transformer

■ Prohibits access to the transformer unless the earthing switch has been locked in the “closed” position.

Type R6 diagram

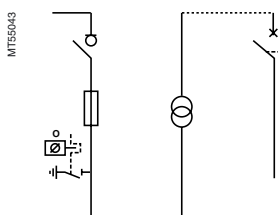

RM6/low voltage

■ Prohibits closing of the earthing switch and access to any protection unit fuses unless the main LV circuit breaker has been locked in the “open” or “disconnected” position.

Type R8 diagram

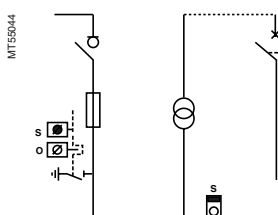

RM6/transformer/low voltage

■ Prohibits closing of the earthing switch and access to any protection unit fuses unless the main LV circuit breaker has been locked in the “open” or “disconnected” position.

■ Prohibits access to the transformer unless the earthing switch has already been “closed”.

MT55045

		absent key
		free key
		captive key

Legend:

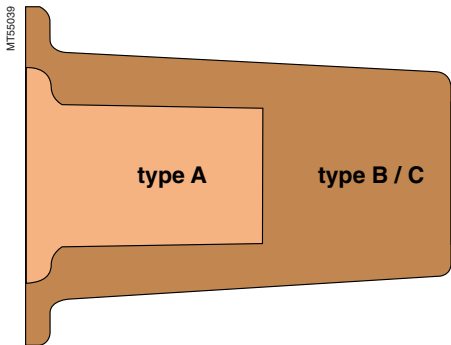

Types of connection interface

This information must be specified for better definition of the connection interfaces.

General

- The profiles, contacts and dimensions of the RM6 connection interfaces are defined by the IEC 60137 standard.
- 100% of the epoxy resin interfaces undergo dielectric testing at power frequency and partial discharge tests.

Appropriateness for use

The bushings carry the electrical current from the outside to the inside of the enclosure, which is filled with SF6 gas, ensuring insulation between the live conductors and the frame.

There are 3 types of bushing, which are defined by their short-time withstand current:

- Type A: 200 A: 12.5 kA 1 s and 31.5 kA peak (plug-in)
- Type B: 400 A: 16 kA 1 s and 40 kA peak (plug-in)
- Type C: 630 A: 25 kA 1 s, 20 kA 3 s and 62.5 kA peak (disconnectable M16).

How to define the connection interface

The connection interfaces depend on specific criteria, such as:

Installation

- Current rating of the connected equipment: 200, 400, 630 A
- Short-time withstand current for 12.5 kA, 16 kA, 25 kA switch and circuit breaker functions
- For the fuse-switch combination function, as the short-circuit current is limited by the fuse, the connection interface will be of type A (200 A)
- Minimum phase expansion length
- Connection type:
 - plug in: multicontact ring
 - disconnectable: bolted.
- Output position: straight, elbow.

Cable

- Specified voltage:
 - of the cable
 - of the network.
- Type of conductor:
 - aluminium
 - copper.
- Cross section in mm²
- Insulation diameter
- Cable composition:
 - single-core
 - 3-core.
- Insulation type:
 - dry
 - paper impregnated (non-draining type).
- Type of screen
- Armature.

Merlin Gerin offers the following *nkt cable* connectors in its offer

Type A bushing
Directed field plug-in connector
Dry single-core cable

Performance	Connection	Supplier	Reference	Cross section	Remarks
7.2 to 17.5 kV	Plug-in	nkt cables GmbH	EASW 12/250 A	25 to 95	Shaped elbow
200 A-95 kV impulse	Plug-in	nkt cables GmbH	EASG 12/250 A	25 to 95	Straight
24 kV	Plug-in	nkt cables GmbH	EASW 20/250 A	25 to 95	Shaped elbow
200 A-125 kV impulse	Plug-in	nkt cables GmbH	EASG 20/250 A	25 to 95	Straight

Type B bushing
Directed field plug-in connector
Dry single-core cable

Performance	Connection	Supplier	Reference	Cross section	Remarks
7.2 to 17.5 kV	Plug-in	nkt cables GmbH	CE 12-400	25 to 300	
400 A-95 kV impulse					
24 kV	Plug-in	nkt cables GmbH	CE 24- 400	25 to 300	
400 A-125 kV impulse					

Type C bushing
Directed field disconnectable connector
Dry single-core cable

Performance	Connection	Supplier	Reference	Cross section	Remarks
7.2 to 17.5 kV	Disconnectable	nkt cables GmbH	CB 12-630	25 to 300	
630 A-95 kV impulse					
24 kV	Disconnectable	nkt cables GmbH	CB 24-630	25 to 300	
630 A-125 kV impulse					

Non-directed field disconnectable connector
Dry single and three-core cable

Performance	Connection	Supplier	Reference	Cross section	Remarks
7.2 to 17.5 kV	Disconnectable	nkt cables GmbH	AB 12-630	25 to 300	For 3-core cable
630 A-95 kV impulse				(+ ATS)	

Type A bushing

Directed field plug-in connector

Dry single-core cable

Performance	Connection	Supplier	Reference	Cross section	Remarks
7.2 to 10 kV 200 A-95 kV impulse	Plug-in	Elastimold	158LR	16 to 120	T-shaped elbow
			151SR	16 to 120	Straight, Q function only
		Pirelli	FMCE 250	16 to 95	
7.2 to 24 kV 200 A-125 kV impulse	Plug-in	Elastimold	K158LR	16 to 95	T-shaped elbow
			K151SR	25 to 95	Straight, Q function only

Type A/M8 bushing

Non-directed field disconnectable connector (*)

Dry single and three-core cable

Performance	Connection	Supplier	Reference	Cross section	Remarks
7.2 to 17.5 kV 200 A-95 kV impulse	Heat shrinkable	Raychem	EPKT+EAKT	16 to 150	
	Insulating boots	Kabeldon	KAP70	70 max.	

(*) 520 mm plinth must be used

Type B bushing

Directed field plug-in connector

Dry single-core cable

Performance	Connection	Supplier	Reference	Cross section	Remarks
7.2 to 10 kV 400 A-95 kV impulse	Plug-in	Elastimold	400 LR	70 to 240	Limited to Us = 10 kV
24 kV 400 A-125 kV impulse	Plug-in	Pirelli	FMCE 400	70 to 300	
		Elastimold	K400LR	35 to 240	
		Kabeldon	SOC 630	50 to 300	

Type C bushing

Directed field disconnectable connector

Dry single-core cable

Performance	Connection	Supplier	Reference	Cross section	Remarks
7.2 to 10 kV 630 A-95 kV impulse	Disconnectable	Elastimold	440 TB	70 to 240	
7.2 to 24 kV 630 A-125 kV impulse	Disconnectable	Pirelli	FMCTs 400	70 to 300	
		Elastimold	K400TB	35 to 240	
		Kabeldon	SOC 630	50 to 300	

Non-directed field disconnectable connector

Dry single and three-core cable

Performance	Connection	Supplier	Reference	Cross section	Remarks
7.2 to 17.5 kV 630 A-95 kV impulse	Heat shrinkable	Raychem	EPKT+EAKT	16 to 300	
		Sigmaform	Q-CAP	16 to 300	
	Insulating boots	Kabeldon	SOC 630	50 to 300	Completed by a kit for three-pole cable
		Pirelli	ELPB12	50 to 300	Limited to 75 kV impulse
	Simplified disconnectable	Raychem	RICS - EPKT	25 to 300	
Euromold		15TS-NSS	50 to 300	Limited to Us = 12 kV	
24 kV 630 A-125 kV impulse	Simplified disconnectable	Raychem	RICS - EPKT	25 to 300	

Type C bushing (cont.)

Non-directed field disconnectable connector

Single-core cable, paper impregnated, non-draining type

Performance	Connection	Supplier	Reference	Cross section	Remarks
7.2 to 17.5 kV	Disconnectable	Pirelli	FMCp400	95 to 300	
630 A-95 kV impulse	Insulating boots	Kabeldon	SOC	25 to 300	
		Pirelli	ELPB12	50 to 300	Limited to 75 kV impulse
	Simplified disconnectable	Raychem	RICS - EPKT	25 to 300	
	Heat shrinkable	Raychem	EPKT+EAKT	95 to 300	
24 kV	Disconnectable	Pirelli	FMCp 1c	95 to 300	
630 A-125 kV impulse	Simplified disconnectable	Raychem	RICS - EPKT	25 to 300	

Non-directed field disconnectable connector

Three-core cable, paper impregnated, non-draining type

Performance	Connection	Supplier	Reference	Cross section	Remarks
7.2 to 17.5 kV	Insulating boots	Kabeldon	SOC 630	25 to 300	
630 A-95 kV impulse		Pirelli	ELPB12	50 to 300	Limited to 75 kV impulse
	Simplified disconnectable	Raychem	RICS - EPKT	25 to 300	
	Heat shrinkable	Raychem	EPKT+EAKT	16 to 300	
24 kV	Simplified disconnectable	Raychem	RICS - EPKT	25 to 300	
630 A-125 kV impulse					

Connectors with lightning arrestors

Disconnectable connector

Single-core dry cable and lightning arrestor

Performance	Connection	Supplier	Reference	Cross section	Remarks
7.2 to 17.5 kV 630 A-95 kV impulse	Disconnectable	nkt cables GmbH	AB 12-630 + ASA12 (5 or 10 kA)	25 to 300	Non-directed field
			CB 24-630 + CSA 24 (5 or 10 kA)	25 to 300	Directed field
24 kV 630 A-125 kV impulse	Disconnectable	nkt cables GmbH	AB 12-630 + ASA12 (5 or 10 kA)	25 to 300	Non-directed field
			CB 24-630 + CSA 24 (5 or 10 kA)	25 to 300	Directed field
7.2 to 17.5 kV 630 A-95 kV impulse	Disconnectable	Raychem	RICS+EPKT RDA 12 or 18	25 to 300	
	Disconnectable	Elastimold	K400TB + K400RTPA + K156SA	35 to 300	Panel with enlarged RM6
24 kV 630 A-125 kV impulse	Disconnectable	Raychem	RICS + EPKT RDA 24	25 to 300	
	Disconnectable	Elastimold	K440TB + K400RTPA + K156SA	35 to 300	Panel with enlarged RM6

Dimensions and installation conditions

Dimensions of non-extensible RM6s

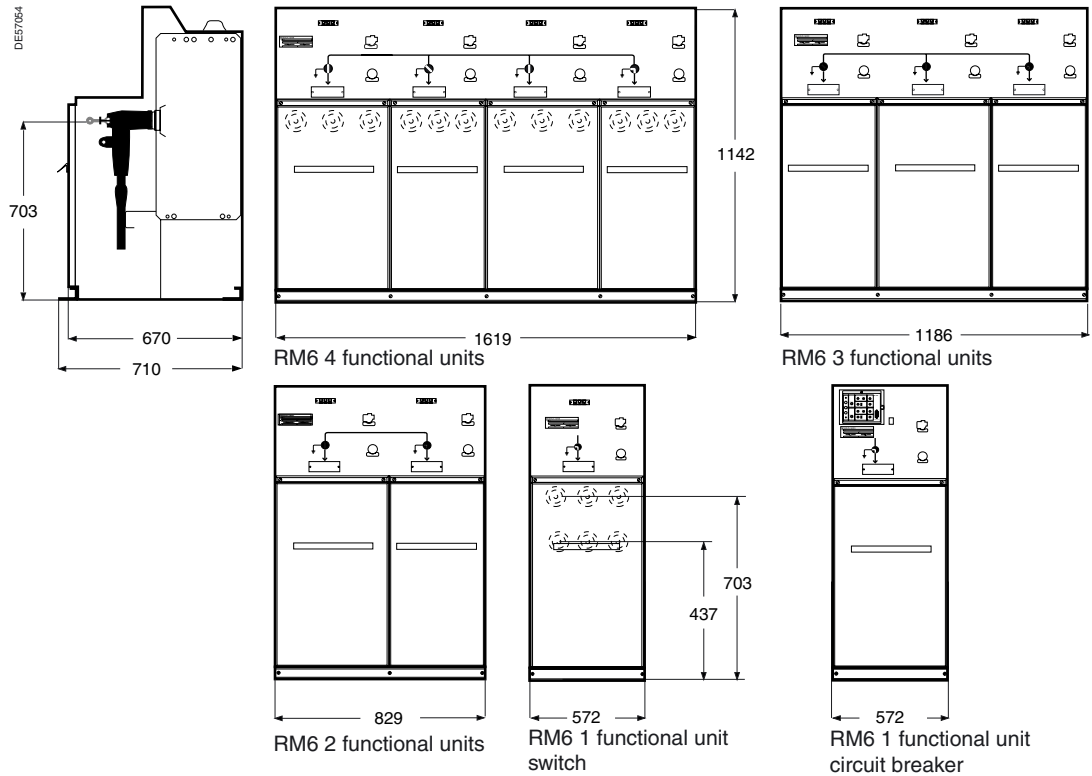

Dimensions of 2, 3 and 4 function RM6 REs that are extensible on the right

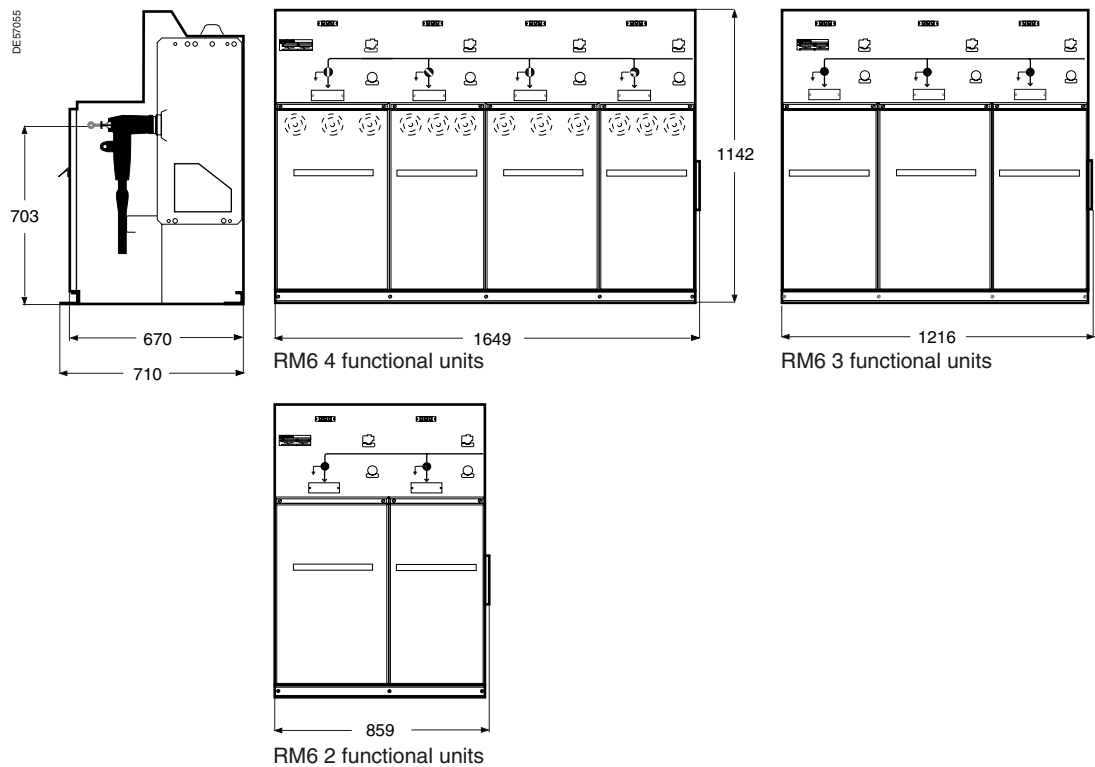

Dimensions of stand-alone RM6 modules cables connections that are extensible

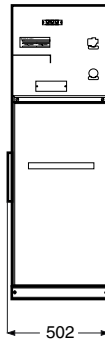
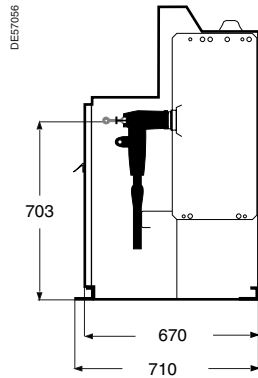

RM6 1 functional cable connection cubicle LE-O

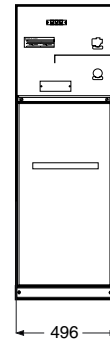

RM6 1 functional cable connection cubicle RE-O

Dimensions of stand-alone RM6 modules that are extensible on both sides

With two bushing protection covers for extensibility

DE57057

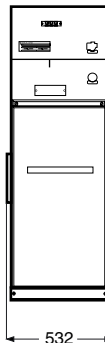

RM6 1 functional unit switch or fuse-switch combination

RM6 1 functional cable connection cubicle DE-O

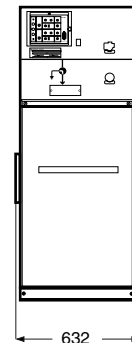

RM6 1 functional unit circuit breaker

Dimensions of the RM6 metering module

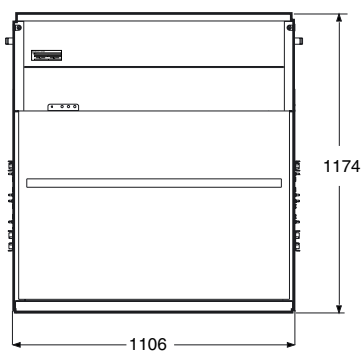
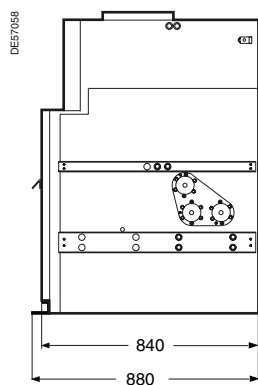

Dimensions of RM6 REs with an extension module

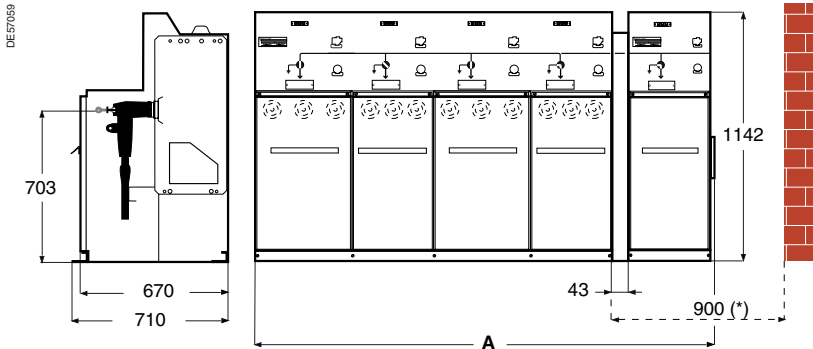

- RM6 RE 3 functional units with switch DE module: **A = 1731 mm**
- RM6 RE 4 functional units with switch DE module: **A = 2164 mm**
- RM6 RE 3 functional units with circuit breaker DE module: **A = 1831 mm**
- RM6 RE 3 functional units with circuit breaker DE module: **A = 2264 mm**

(*) Dimensions necessary on the right of the RM6 in order to install an extension.

Layout

Floor mounting

The RM6 is supported by 2 metal feet with holes for mounting:

- on a flat floor fitted with trenches, passages or ducts
- on concrete footing
- on studs
- on metal rails
- etc.

Non-extensible RM6 (top view)

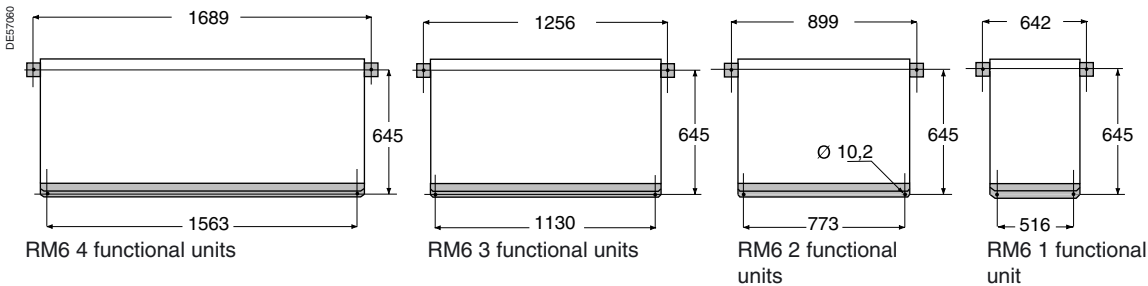

Extensible RM6 (top view)

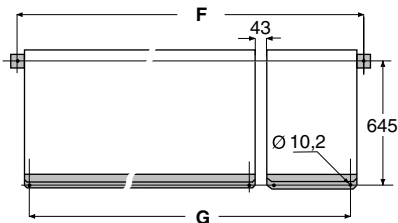

RM6 3 or 4 functional units with extensibility module

RM6 3 functional units with switch or combined switch	F = 1771 mm
	G = 1645 mm
RM6 3 functional units with circuit breaker	F = 1871 mm
	G = 1745 mm
RM6 4 functional units with switch or combined switch	F = 2204 mm
	G = 2078 mm
RM6 4 functional units with circuit breaker	F = 2304 mm
	G = 2178 mm

Wall mounting

There are two holes allowing the unit to be fixed on the wall as well as mounted on the floor.

Additional raising plinth

As an option, the RM6 can be fitted with a 260 or 520 mm raising plinth. This addition, which simplifies civil engineering works, results in trenches of a smaller depth, or even in their complete elimination when the bending radius of the cables allows it.

The plinth is mounted directly on the floor.

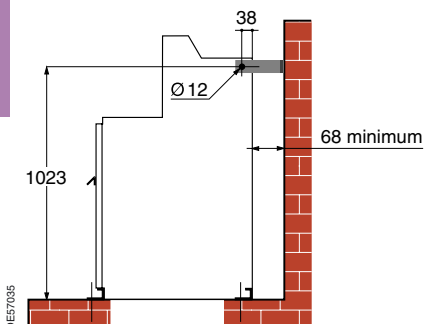

Installation of the substation for internal arc withstand

When there is a requirement for installations with protection against internal arc faults, refer to the following diagrams.

Gas removal to the rear of the substation

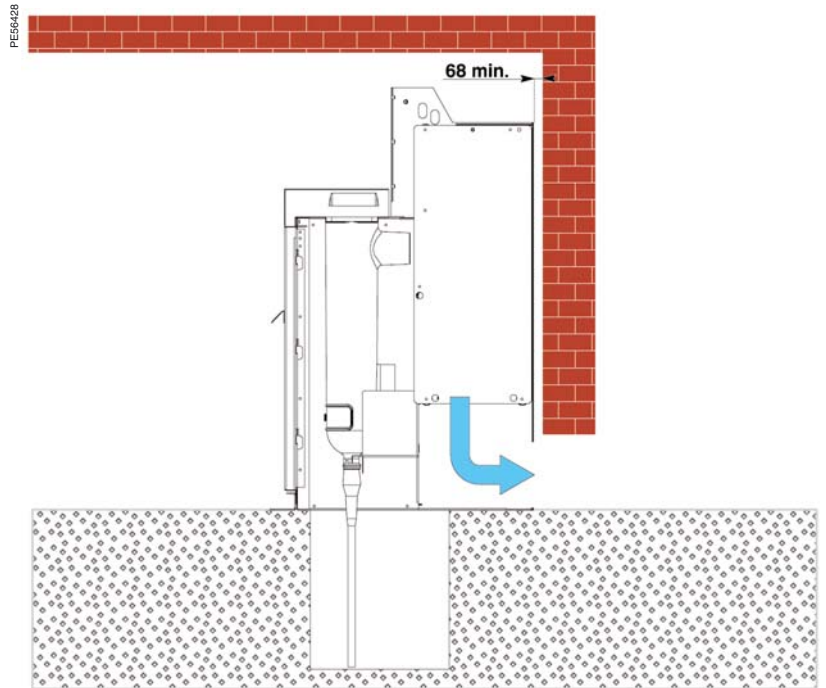

Gas removal to the upstream compartment

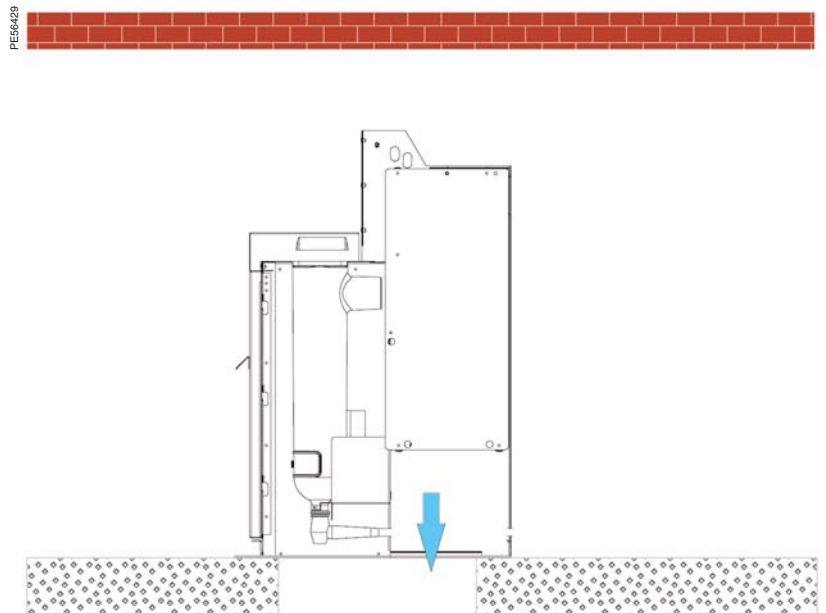

N.B.: parts for guiding the gases to vent openings and cooling walls are not part of the switchgear supply. These must be adapted to each specific case.

For connection to “network” or “transformer” via circuit breaker

The “network” cables can be run either:
 ■ through trenches, passages, ducts
 ■ through the left or the right side.

Trench depth P or RM6 without plinth
Note: trench depths can be reduced and sometimes eliminated by adding a plinth.

Cable entry through a trench

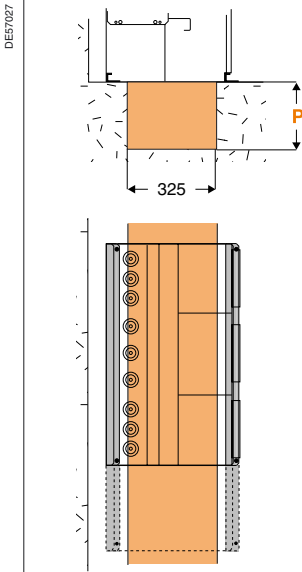

Cable entry through a duct

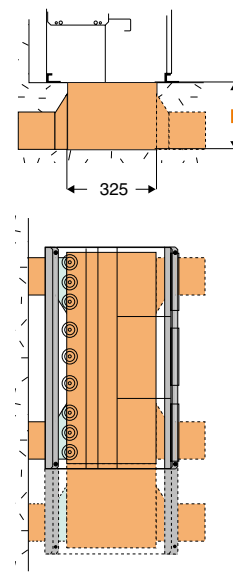

Cable insulation	Cable	Cross-section (mm ²)	Bending radius	Plug-in P	Disconnectable P	Plug-in P	Disconnectable P
Dry insulation	Single	≤ 150	500	400		400	
		185 to 300	600	520		520	
	Three	≤ 150	550	660		660	
		185	650	770		770	
Paper impregnated non-draining type	Single	≤ 150	500		580		580
		185 to 300	675		800		800
	Three	≤ 95	635		750		750
		150 to 300	835		970		970

For “transformer” connection via fuse-switch

The cross-sections of “transformer” cables are generally smaller than those of the “network” cables. All the cables are then run through the same space. When straight MV connectors are used, the depth P indicated below can be greater than that of the “network” cables.

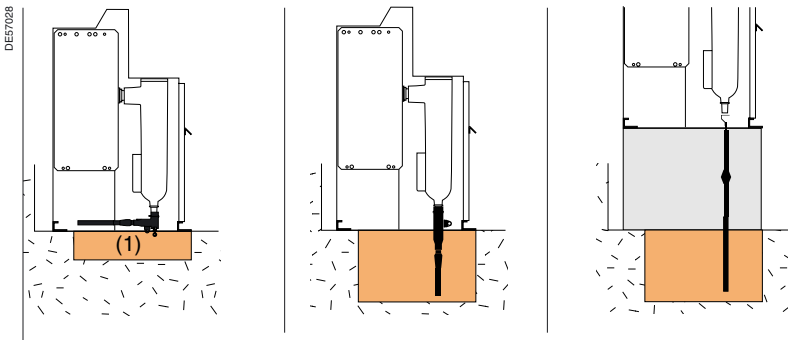

Cable insulation	Cable	Cross-section (mm ²)	Bending radius	Plug-in Elbow connector	Plug-in Straight connector	Disconnectable (2) P
Dry insulation	Single	16 to 35	335	100	520	335
		50 to 70	400	100	520	440
		95 to 120	440	100	550	440
	Three	35	435		520	725
		50 to 70	500		520	800
		95	545		550	860

(1) Leave a clearance of 100 mm
 (2) 520 mm plinth must be used

Basic unit characteristics																			
Rated voltage	(kV)	12	12	12	12	17.5	17.5	17.5	17.5	24	24	24	24	24	24	24	24	24	
Short-time withstand current	(kA rms)	21	21	25	25	21	21	21	21	12.5	12.5	12.5	16	16	16	20	20	20	
	Duration (s)	1	1	1	1	1	3	1	3	1	1	1	1	1	1	1	3	1	
Rated current	(A)	200	630	200	630	200	200	630	630	200	400	630	200	400	630	200	200	630	
Extensions	Functions																		
NE	I				■			■		■	■			■	■			■	
	D	■		■		■				■			■			■			
	B				■			■	■						■			■	
	QI				■		■			■			■			■			
	DI				■		■			■			■			■			
	BI				■			■	■						■			■	
	II				■			■			■			■	■			■	
	IQI		■		■			■	■		■			■	■			■	■
	IIQI		■		■			■	■		■			■	■			■	■
	QIQI		■		■			■	■		■			■	■			■	■
	IDI				■			■	■		■	■		■	■			■	■
	IIDI				■			■	■		■	■		■	■			■	■
	DIDI				■			■	■		■	■		■	■			■	■
	III				■			■	■		■			■	■			■	■
	IIII				■			■	■		■			■	■			■	■
	IBI				■			■	■		■			■	■			■	■
	IIBI				■			■	■		■			■	■			■	■
	BIBI				■			■	■		■			■	■			■	■
RE	O				■	■		■		■			■		■	■		■	
	IQI		■		■			■	■		■			■	■			■	■
	IIQI		■		■			■	■		■			■	■			■	■
	QIQI		■		■			■	■		■			■	■			■	■
	IDI				■			■		■	■		■	■			■	■	
	IIDI				■			■		■	■		■	■			■	■	
	DIDI				■			■		■	■		■	■			■	■	
	II				■			■		■			■	■			■		
	III				■			■	■		■			■	■			■	■
	IIII				■			■	■		■			■	■			■	■
	IBI				■			■	■		■			■	■			■	■
	IIBI				■			■	■		■			■	■			■	■
BIBI				■			■	■		■			■	■			■	■	
LE	O				■	■		■		■			■		■	■		■	
	DE				■	■		■		■			■		■	■		■	
DE	I				■			■	■		■			■	■			■	■
	BC				■			■		■				■				■	■
	IC				■			■		■				■				■	■
	O				■	■		■		■			■		■	■		■	
	Q	■		■		■	■			■			■		■		■		
	D				■		■			■			■			■		■	
	B				■			■	■		■			■	■			■	■
	Mt				■			■		■				■				■	■

N.B.: D and Q functions limited to 200 A
 NE: non-extensible, RE: extensible to the right, LE: extensible to the left, DE: double extensible.

Only one of the boxes (ticked or filled by the needed value) have to be considered between each horizontal line.

Orange box corresponds to none priced functions.

Basic unit configuration

Quantity

	4th function	3rd function	2nd function	1st function
Configuration (one function per box, fill in from the right)	<input type="text"/>	<input type="text"/>	<input type="text"/>	<input type="text"/>
Example →		I	D	I

Option for I, D, B, Q functions

Auxiliary contacts alone

For main switch position indication 2 NO - 2 NC and ESw 1 O/C (this option is included in remote operation option)

Option for I function (Load-Break Switch "LBSw")

Arc short-circuiting device

Front door of cable connection compartment

- Bolted
- Removable with ESw interlocking
- Removable with ESw interlocking and LBSw interlocking

Self-powered fault passage indicators

- Flair 21D
- Flair 21DT
- Flair 22D

Short-circuit current setting	200 A	400 A	600 A	800 A
Front door with window (for checking of liquid type short-circuit indicator - not supplied)	<input type="checkbox"/>	<input type="checkbox"/>	<input type="checkbox"/>	<input type="checkbox"/>
50 Hz	60 Hz	120 Vac	220 Vac	
24 Vdc	48 Vdc	60 Vdc		
110 Vdc	125 Vdc	220 Vdc		

Remote operation on I function

Motor mechanism and auxiliary contacts LBSw 2 NO - 2 NC and ESw 1 O/C

Option for D or B function (Circuit Breaker "C.B.")

Front door of cable connection compartment (only if this option is chosen with I function)

- Bolted
- Removable with ESw interlocking
- Removable with ESw interlocking et and C.B. interlocking

Protection relay for C.B. transformer protection (only one VIP type per unit)

- Relay VIP30 (over current)
- Relay VIP35 (over current and earth fault)
- Relay VIP300 (over current & earth fault/multi curve in accordance with IEC 255-3)

Forbidden closing under fault 1NC

Auxiliary contact D or B tripping

Shunt trip coil for external tripping

50 Hz	60 Hz	120 Vac	220 Vac
24 Vdc	48 Vdc	60 Vdc	
110 Vdc	125 Vdc	220 Vdc	
50 Hz	60 Hz	120 Vac	220 Vac
24 Vdc	48 Vdc	60 Vdc	
110 Vdc	125 Vdc	220 Vdc	

Remote operation on D or B function

Motor mechanism and auxiliary contacts C.B. 2 NO - 2 NC and ESw 1 O/C (including shunt trip coil)

Option for Q function (fuse combination)

Auxiliary contact for fuses blown

Shunt trip coil for external tripping

50 Hz	60 Hz	120 Vac	220 Vac
24 Vdc	48 Vdc	60 Vdc	
110 Vdc	125 Vdc	220 Vdc	

Option for D, B, Q functions

Undervoltage coil

24 Vdc	48 Vdc	120 Vac	220 Vac
		110 Vdc	

Option for operation

Voltage indicator

- VPIS
- VDS

Network service voltage	3.2/7.2 kV
	10/24 kV

Key locking devices

Type R1 (on I and B functions)

Ronis	Profalux
On switch or C.B.	
On earth switch	

Type R2 (on I and B functions)

Type R6 (on Q or D functions)

Type R7 (on Q or D functions)

Type R8 (on Q or D functions)

Only one of the boxes (ticked or filled by the needed value) have to be considered between each horizontal line.

Orange box corresponds to none priced functions.

Specific option for one function

Bushing for I function

Plug in 400 A type B	<input type="checkbox"/>
Bolted M16 screw type C (compulsory with 17.5 or 24 kV-630 A)	<input type="checkbox"/>
Bolted 5/8" ANSI	<input type="checkbox"/>

Bushing for D function

Plug in 200 A type A (limited to 12.5 kA 1 s)	<input type="checkbox"/>
Plug in 400 A type B (limited to 16 kA 1 s)	<input type="checkbox"/>
Bolted M16 screw type C (compulsory with 17.5 or 24 kV-630 A)	<input type="checkbox"/>
Bushing well ANSI (limited to 12.5 kA 1 s)	<input type="checkbox"/>

Bushing for B function

Bolted M16 type C	<input type="checkbox"/>
Bolted 5/8" ANSI	<input type="checkbox"/>

Bushing for Q function

Plug in 200 A	<input type="checkbox"/>
Heat shrinkable terminal for fuse chamber	<input type="checkbox"/>

Cable type for I function	Single core <input type="checkbox"/>	Three-core <input type="checkbox"/>
Bottom plate in cable compartment (compulsory in case of three-core cable)		

Cable type for D or B function	Single core <input type="checkbox"/>	Three-core <input type="checkbox"/>
Bottom plate in cable compartment (compulsory in case of three-core cable)		

In and fuse type for Q function	6 kV <input type="checkbox"/>	10 kV <input type="checkbox"/>	12/24 kV & 10/100 A <input type="checkbox"/>
(fuses to be procured separately)	16 to 100 A <input type="checkbox"/>	125 A <input type="checkbox"/>	

Global option

Manometer	Without <input type="checkbox"/>	Arabic <input type="checkbox"/>	Standard <input type="checkbox"/>	Scandinavian <input type="checkbox"/>
------------------	----------------------------------	---------------------------------	-----------------------------------	---------------------------------------

Lightning arrester on incoming functions

(unable to coexist with internal arc cable box and only Elastimold)

Additional earth busbar in cable compartment

(compulsory if earth fault > 6 kA 1 s)

Internal arc cable box 20 kA 1 s for I and D or B functions

(unable to coexist with short-circuit indicator liquid type)

Accessories

Raising plinth	h = 260 mm <input type="checkbox"/>	h = 520 mm <input type="checkbox"/>
-----------------------	-------------------------------------	-------------------------------------

Set of 3 MV fuses Fusarc CF	Rating (A) <input type="text"/>
------------------------------------	---------------------------------

Phase comparator

Test box for circuit breaker relay (VAP 6)

Additional operating handle	Operating handle <input type="checkbox"/>	Enlarged operating handle <input type="checkbox"/>
------------------------------------	---	--

Additional instructions

Installation and civil engineering instructions	French <input type="checkbox"/>	English <input type="checkbox"/>
---	---------------------------------	----------------------------------

Connectors and adaptaters for RM6

Quantity

Connectors for 630 A (1 set = 1 function)

Directed field disconnectable connector

CB 24-630 A	<input type="checkbox"/>
CB 24-630 A with CC-630 A (coupling connection)	<input type="checkbox"/>

Non-directed field disconnectable connector

AB 15-630 A	<input type="checkbox"/>
AB 15-630 A with AC 15-630 A (coupling connection)	<input type="checkbox"/>

Connectors for 400 A (1 set = 1 function)

Directed field plug-in connector	CE 24-400 A	<input type="checkbox"/>
---	-------------	--------------------------

Connectors for 250 A (1 set = 1 function)

Elbow connector	EASW 20-250 A	<input type="checkbox"/>
Straight connector	EASG 20-250 A	<input type="checkbox"/>

Schneider Electric Industries SAS

89, boulevard Franklin Roosevelt
F - 92500 Rueil-Malmaison (France)
Tel.: +33 (0)1 41 29 85 00

<http://www.schneider-electric.com>
<http://www.merlin-gerin.com>

AMTED398032EN

As standards, specifications and designs develop from time to time,
always ask for confirmation of the information given in this publication.



*This document has been
printed on ecological paper*

Publishing: Schneider Electric
Design: Graphème
Printing: Imprimerie du Pont de Claix/JPF - Made in France